



A4|S4



Contents

This guide is designed to help you explore the features and options of the Audi A4 and S4. You can also configure your perfect model using our online configurator, at www.audi.co.uk/configurator

The images featured in this guide are for illustrative purposes only and may feature left-hand drive vehicles and include equipment that is not UK specification.

Page 4

The Audi A4

The all-new Audi S4

Page 32

Vorsprung durch Technik in your Audi A4

Page 46

Build your A4

Model choice	Page 48	Seating and upholstery	Page 78
Paint	Page 64	Inlays	Page 90
Wheels	Page 66	Interior equipment	Page 92
Performance		Technology Packs	Page 96
and suspension	Page 68	Technology - Audio	
Lighting	Page 70	and communication	Page 102
Exterior Styling Pack	Page 72	Technology - Driver assistance	Page 106
Exterior equipment	Page 74	Audi Genuine Accessories	Page 112
		Audi warranty	Page 113

Page 114

Audi glossary

Page 118

Technical specifications and dimensions

Page 132

Buying and maintaining your A4

The Audi Difference	Page 132	Important information	Page 134
Financing your Audi A4	Page 133		



The Audi A4

It's lighter, more agile and more advanced than its predecessor. We've enhanced almost every part of the Audi A4, bringing innovative features to the cabin and putting more power under the bonnet. The design has been refined, the technology has advanced and we've updated our range of engines and transmissions. The only thing that hasn't changed is the name.





The Exterior

Poise, elegance, precision

The A4 features sharper lines than before, with a bolder shape and a lower stance. From the shoulder line that runs the length of the car, to the detailed styling of headlights and sculptured air intakes, the latest-generation A4 has a distinctive presence.



Dynamic, sporty, streamlined

Thanks to advanced engineering and manufacturing, the gaps between body panels are now visibly tight. The effect is a seamless flow of contours, evident in every detail. Making the A4 one of the most precisely engineered cars we've ever made.







Performance

Agility and comfort at every turn

We've redesigned our engines, enhanced our transmissions and finely tuned our suspension options. The next generation, 7-speed S tronic transmission is now available for the first time for front-wheel drive. Electromechanical steering, together with the lightweight five-link front and rear suspension, improves agility and comfort on the road.



Lighter and more powerful

Lighter weight improves fuel economy. So we've used materials intelligently to make the Audi A4 up to 120kg lighter than its predecessor – for example, combining hot-formed steel and aluminium in the body. Yet at the same time, every engine option has improved performance. It's not because of just one change; rather, the result of hundreds of improvements we've made throughout the car.









The Interior

A cabin that surrounds you

With its wraparound design and generous headroom, the interior of the Audi A4 is designed to provide a feeling of space and safety. The air vents and 3D inlay run the width of the cabin in a long, unbroken line. The plunging centre console lends a 'floating' aspect to the low-profile dashboard with its large, yet slimline MMI display. And small details add to the feeling of refinement, like touch switches for the climate control or the S tronic gear lever that also acts as a hand rest for the MMI system.



Quietly brilliant

The Audi A4's improved aerodynamics don't just reduce drag and fuel consumption; they also lessen wind and road noise for a quiet, relaxed drive. It's more spacious than its predecessor, which means passengers in the front and rear are immersed in a feeling of comfort. There's extra room for cargo too, with a redesigned boot. In fact, the A4 Avant offers over 500 litres with the rear seats up and over 1,500 litres when the rear seats are down.





Technology

Bring your A4 to life

It's the latest technology options that really define the A4. Audi Virtual Cockpit, which transforms the instrument cluster at the touch of a button. Driver assistants that watch the road intelligently. A head-up display which puts the information you want right where you need it. These options represent the very pinnacle of Audi technology.



S4

Beautiful design, exceptional performance.

Behind the Audi S4's imposing 'S' grille and LED headlights lies a V6 engine that can power this car from 0-62mph in just 4.7 seconds (4.9 seconds for the S4 Avant). Every part is built for performance, from the smooth-shifting tiptronic transmission to the 'S' Sport suspension that provides a true racing feel.





S4

Technology meets luxury.

The Audi S4 includes a wide range of technology as standard to put you in control, and luxurious features to help you drive in comfort. MMI Navigation Plus includes an 8.3" high-resolution colour display and MMI Touch control. And not only are the Fine Nappa leather S Super Sport seats heated, they also offer a special pneumatic massage function – particularly useful on long journeys.

Vorsprung durch Technik



Not just a slogan. A philosophy

Progress. It's behind everything we do at Audi. It's why, in the A4, we've incorporated new technologies to help you on the road and new engines to deliver enhanced performance and fuel economy.

The Audi A4 is the embodiment of our forward-thinking approach.



quattro

Driving confidence, whatever the weather

Loose gravel. Icy patches. A tight bend in the rain. Conditions on the road are always changing, so quattro changes too. Available with a variety of engines across Sport and S line trims and standard on S4, it analyses your grip – automatically distributing power between all four wheels to where it's needed most. It's made for the most challenging conditions of all – the ones you encounter every day. Whatever the road holds, you can be confident that quattro will react.



Audi A4 ultra range

The Audi A4 ultra is available as a Saloon or Avant. Both models offer efficient 150PS or 190PS 2.0 TDI engines, as well as the choice of 6-speed manual and, for the first time, 7-speed S tronic transmissions.

The A4 ultra engines are faster, more powerful and emit up to 8% less CO₂ than their predecessors. Across Saloon and Avant SE, Sport and S line models, 16 variants are available on both 17" and 18" wheels, including the A4 Saloon 2.0 TDI ultra 150PS manual on the SE and Sport trim with CO₂ emissions of 99g/km.* Our ultra range ensures you have a choice, whatever your requirements are.

A4 Saloon

2.0 TDI 150PS ultra (with 17" wheels)		2.0 TDI 190PS ultra (with 17" wheels)	
Manual	S tronic	Manual	S tronic
99g/km CO ₂ *	101g/km CO ₂ *	102g/km CO ₂ *	103g/km CO ₂ *
19% BIK	20% BIK	20% BIK	20% BIK
MPG* Urban: 62.8 Extra Urban: 83.1 Combined: 74.3	MPG* Urban: 60.1 Extra Urban: 80.7 Combined: 72.4	MPG* Urban: 58.9 Extra Urban: 80.7 Combined: 72.4	MPG* Urban: 60.1 Extra Urban: 80.7 Combined: 70.6

A4 Avant

2.0 TDI 150PS ultra (with 17" wheels)		2.0 TDI 190PS ultra (with 17" wheels)	
Manual	S tronic	Manual	S tronic
104g/km CO ₂ *	104g/km CO ₂ *	106g/km CO ₂ *	106g/km CO ₂ *
20% BIK	20% BIK	21% BIK	21% BIK
MPG* Urban: 60.1 Extra Urban: 78.5 Combined: 70.6	MPG* Urban: 58.9 Extra Urban: 78.5 Combined: 70.6	MPG* Urban: 56.5 Extra Urban: 76.3 Combined: 68.9	MPG* Urban: 58.9 Extra Urban: 78.5 Combined: 68.9

Please refer to pages 120-121 and 124-125 for the technical data of ultra engines on 18" wheels



*Standard EU test figures for comparative purposes and may not reflect real driving results. ultra TDI models come with a 40-litre fuel tank and a 12-litre AdBlue® tank as standard. A larger 54-litre fuel tank and 24-litre AdBlue® tank are available as free of charge options – please see page 74. ultra TDI models come with low rolling resistance tyres. **Benefit in kind (BIK) figures are for the 2016/2017 tax year.



Matrix

LED lights

Illuminating features

The Audi A4's optional Matrix LED headlights produce a light similar in colour to daylight. They also incorporate sensors and an inbuilt camera that detects other road users, as well as ambient light in built-up areas. They then react by dipping individual LEDs to reduce the risk of dazzling other road users, while still fully illuminating the remainder of the road.

Where available, Matrix LED technology will even use the vehicle's navigation data to anticipate corners, adjusting LEDs as you negotiate the bend. The result is a much wider visual range, benefitting both you and other road users. Dynamic sweeping indicators complete the striking look at the front and rear.



Bring your phone to the fore

Imagine being able to use your smartphone applications safely while driving. The Audi Smartphone Interface, standard across the A4 range, lets you do just that.

Satellite navigation. Music streaming. Your contact list. Now you can access apps, approved for in-car use by Android and Apple, from the MMI controls on the centre console, from the multi-function steering wheel, Audi Voice Control, or even via your smartphone's assistant, like Siri.

Simply connect your compatible smartphone via USB* and approved apps appear in full colour on the central MMI screen.



Smartphone Interface

Finding your way



You can now use Apple and Google Maps™* as your navigation system. Turn-by-turn directions, traffic guidance and estimated arrival times are easy to see on your MMI screen without having to touch your phone – and addresses from your email, texts, contacts and calendar can be added as destinations. Don't forget, planning your journey at home reduces data usage while on the move.



Google Maps™*

Your own soundtrack



You can play music stored on your phone as you drive, controlling it simply and intuitively through the interface. Streaming services are also available, including Spotify and Google Play Music.*

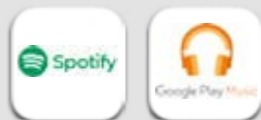

Spotify and Google Play Music*

Keeping in touch



With Audi Smartphone Interface, any text messages you receive while driving can be read out to you – and if you need to respond, you can do so simply by dictating your message. But not only that. You can also use approved third-party apps* like WhatsApp to keep in touch while driving.



WhatsApp, Skype and Google Hangouts*

What's on your phone is now available on the road

The Audi Smartphone Interface makes linking your smartphone* to your car quick, safe and easy.

With Android Auto and Apple CarPlay, you can access approved apps* from your phone safely via the Audi MMI system – both by voice or fingertip control. So you can make calls, receive and dictate messages, navigate, select music and podcasts and much more without taking your eyes off the road.

All imagery on these pages show use of Apple CarPlay with Audi Smartphone Interface. *Smartphone Interface uses Apple CarPlay, which is available with iPhone 5 and above, or Android Auto, which is available with phones using Android 5.0 Lollipop or above. *Availability of applications differs by operating system and is dependent on approval by Apple or Google. An up-to-date list of approved apps is available on the relevant systems' websites. Permanent availability cannot be guaranteed as this is the responsibility of Apple and Google. Use of certain apps with Smartphone Interface will be subject to signal availability of the mobile network in your location and in-car usage may increase your mobile data usage. If using regularly, a mobile phone contract including an unlimited or high amount of data is recommended.

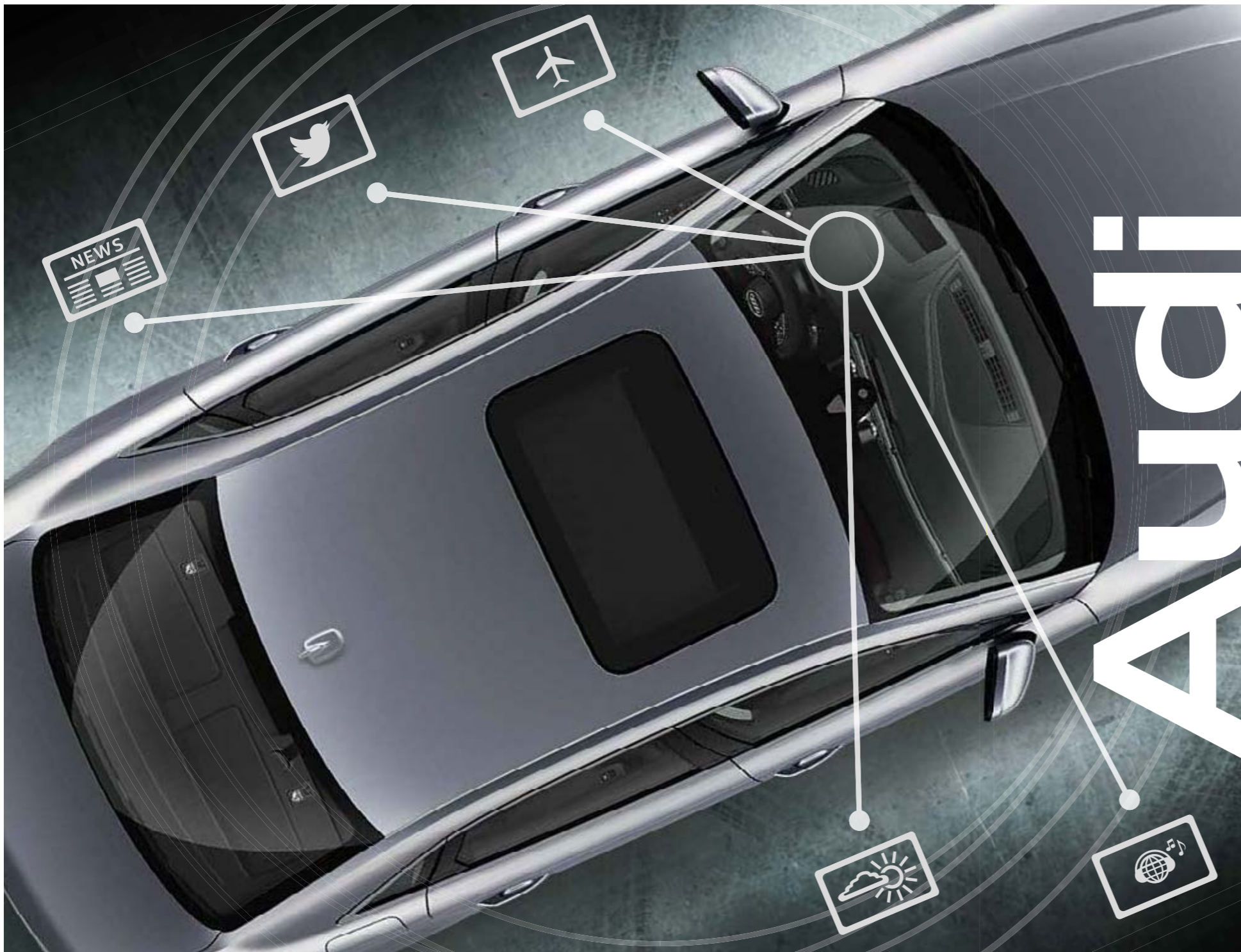

Audi

Connect

Infotainment Services

The world at your fingertips

Audi Connect Infotainment Services is the link between your Audi and the internet, giving you access to entertainment, information and search functions via scrolling, tapping or verbal commands.

With high-speed 4G internet access in your car, via an embedded SIM card with no data charge, you can call up flight information, fuel prices and weather, as well as high-resolution aerial and satellite pictures from Google Earth™ and Google Street View™.

Audi Connect Infotainment Services is available as a 3-month trial on Sport and S line models or a 36-month subscription is available to purchase as part of the Technology Pack. S4 models come with the 36-month subscription as standard.



Audi Connect

Infotainment Services

Stay connected on the move

The following Audi-supported services are currently available:

Infotainment



Online media streaming Pairing a smartphone with the Audi Music stream app offers access to worldwide radio stations and music stored on the smartphone



Weather information Gives you forecasts and maps for your chosen destination



News online (individual) Text and images from your favourite news sources with text-to-speech function



Country-specific information*
The legal regulations for a specific country, such as speed limits or whether it is compulsory to carry a high-visibility vest or display a motorway toll sticker, are displayed when crossing a border

Communication



Twitter Enables you to tweet and receive updates on the move, with text-to-speech and other convenient text functions



Email** Your emails can be transmitted to your Audi MMI and read out conveniently

Mobility and navigation



Points of interest
Search Google™ using voice control



Navigate with Google Earth™ and Google Street View™
Uses high-resolution aerial and satellite images as well as photos to guide you to your destination with ease

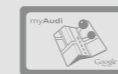

Destination entry via myAudi or Google Maps™
If required, navigation destinations can be conveniently planned on your PC or smartphone. myAudi and Google Maps™ allow individual navigation destinations to be sent to the vehicle. When you start your journey, these can be easily loaded as your destination. myAudi or Google account required



myAudi – special destinations*
Import individual points-of-interest (POI) lists to your Satellite Navigation system via the myAudi portal



Map update online* The map version delivered can be updated free of charge with the first five navigation updates which are issued at intervals of six months. In combination with Audi Connect Infotainment Services, the update can be carried out online in the vehicle



Flight information Get information about departure and arrival times, as well as the corresponding gates, and search directly for flight numbers



Train information Find departure and arrival times and platform information while you're on the road (also available for other types of public transport such as underground systems)



Fuel prices Information on filling stations with the cheapest prices in your selected search area



Parking information Helps you find car parks nearby and, where available, information on prices and currently vacant spaces



Traffic information online Complements the dynamic route guidance with real-time traffic flow information for individual stretches of road

Virtual Cockpit

Customisable control

The information you need is always changing, so the Audi Virtual Cockpit changes too. Available as an option, it replaces the traditional dashboard with a high-resolution, 12.3" LCD screen, which you can customise just by pressing the 'view' button on the multi-function steering wheel. Choose the 'classic' view, with prominent speedometer and rev counter, or the 'infotainment' view, which brings functions such as the navigation map or media to the fore – with crisp 3D graphics and highly detailed effects.

Everything you need to know right in front of you: it's the embodiment of Vorsprung durch Technik.



How to build your Audi A4

Choose your trim and body style then select your options

The following sections of this guide are designed to make it easy for you to create the Audi you've always imagined.



Stage 1. Model choice

Choose A4 or S4 Saloon or Avant
Page 48

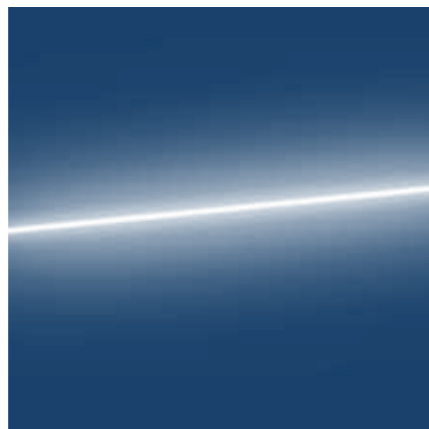

Stage 2. Paint

Standard or optional paint finishes
Page 64



Stage 3. Wheels

17", 18" and 19" alloy wheels
Page 66



Stage 4. Performance and suspension

Steering and suspension Page 68



Stage 5. Lighting

Advanced lighting technology options
Page 70



Stage 6. Exterior equipment

Options for exterior finishing touches
Page 72



Stage 7. Seating and upholstery

Seats, colours and trim options
Page 78



Stage 8. Inlays

Standard or optional
Page 90



Stage 9. Interior equipment

Options for interior finishing touches
Page 92



Stage 10. Technology Packs

Advanced technology options,
bundled for value
Page 96



Stage 11. Technology – Audio and communication

Options for music, entertainment
and information Page 102



Stage 12. Technology – Driver assistance

Advanced options for safety and visibility
Page 106

A4 SE

Key features that come as standard.

SE offers premium specification as standard. Highlights include Xenon headlights with LED daytime-running lights, Audi Smartphone Interface, 3-zone climate control and a 7" colour MMI monitor. In Avant versions, a power operated tailgate and an electrically retracting luggage cover are also standard, facilitating access to the Avant's accommodating load bay.

Wheels

- ▶ 17" '10-spoke crystal' design alloy wheels
- ▶ ultra TDI models come with low rolling resistance tyres
- ▶ Space-saver spare wheel
- ▶ Tool kit and car jack
- ▶ Rear diffuser clip in chrome
- ▶ Chrome-plated exhaust trims
- ▶ Aluminium roof rails (Avant models only)
- ▶ High-gloss package – roof frame and window trims in Aluminium, B-pillar trims and triangular rear door trim in High-gloss black
- ▶ Door mirrors – electrically adjustable and heated with integrated LED side indicators
- ▶ Body-coloured door mirrors
- ▶ Tow bar preparation
- ▶ Windscreen with acoustic glazing

Performance and suspension

- ▶ Automatic Start-Stop with coasting functionality and efficiency programme
- ▶ Electromechanical power steering
- ▶ Comfort Dynamic suspension (ultra TDI models come with Sport suspension)
- ▶ Audi Drive Select

Lighting

- ▶ Xenon headlights with LED daytime-running lights

Exterior equipment

- ▶ Radiator grille in Titan black with chrome inlays
- ▶ Air inlets in Titan black
- ▶ Door handles with chrome inlay
- ▶ Rear diffuser in Titan black, matt

Seats

- ▶ Standard seats in Concept cloth
- ▶ Manual seat adjustment
- ▶ Split-folding rear seat bench in three parts (40/20/40) with rear centre armrest

Inlays

- ▶ Inlays in Aluminium Ellipse, silver

Interior equipment

- ▶ Deluxe 3-zone electronic climate control

- ▶ 3-spoke leather multi-function steering wheel with chrome clip (and paddles for automatic transmissions) – height and reach-adjustable
- ▶ Door sill trims with Aluminium inlay
- ▶ Auto-dimming rear-view mirror
- ▶ Front centre armrest
- ▶ Electric boot lid release – Saloon models only
- ▶ Power operated tailgate – Avant models only
- ▶ Electric load area cover – Avant models only
- ▶ Interior lighting

Audio and communication

- ▶ MMI Radio Plus with 7" colour MMI screen
- ▶ Audi Smartphone Interface
- ▶ Driver's Information System – 5" monochrome display
- ▶ Voice control
- ▶ Bluetooth interface[†]
- ▶ DAB digital radio reception
- ▶ 8 passive loudspeakers
- ▶ Two USB charging ports
- ▶ CD drive
- ▶ Navigation preparation ('Ready 4 Nav')

Driver assistance

- ▶ Cruise control system with speed limiter. Free-wheeling capability on models with automatic transmissions
- ▶ Parking System Plus – front and rear parking sensors
- ▶ Keyless go
- ▶ Pre-sense city
- ▶ Multi-collision brake assist

Safety and security

- ▶ Pop-up bonnet for pedestrian protection
- ▶ Electronic Stabilisation Control (ESC), including ABS, ASR and EDL
- ▶ Light and rain sensor
- ▶ Anti-theft alarm
- ▶ ISOFIX child seat mounting and Top Tether
- ▶ 6-airbag system
- ▶ Anti-theft wheel bolts
- ▶ First aid kit with warning triangle
- ▶ Seat belt monitoring

	Petrol			Diesel	
Engine	1.4 TFSI	2.0 TFSI	2.0 TFSI	2.0 TDI ultra	2.0 TDI ultra
Power	150PS	190PS	190PS	150PS	150PS
Transmission	6-speed manual	6-speed manual	7-speed S tronic	6-speed manual	7-speed S tronic
Saloon					
CO ₂ g/km*	126	127	116	99	101
RRP inc VAT**	£25,665	£27,465	£28,995	£28,915	£30,445
Recommended OTR**	£26,350	£28,150	£29,680	£29,600	£31,130
Avant					
CO ₂ g/km*	131	132	121	104	104
RRP inc VAT**	£27,065	£28,735	£30,395	£30,315	£31,845
Recommended OTR**	£27,880	£29,550	£31,080	£31,000	£32,530

[†]For mobile phone and software version compatibility, please visit your Audi Centre or www.audi.co.uk/phonecompatibility. For more details on the items listed above, please see the Glossary on pages 114-117. *Standard EU test figures for comparative purposes and may not reflect real driving results. Optional alloy wheels may also affect CO₂ emissions and fuel consumption figures. This may lead to a change to the VED amount payable. Please refer to pages 66-67, 120-121, 124-125 and 135. Values based on standard EU test figures for comparative purposes and may not reflect real driving results. **RRP including VAT, includes VAT at 20%, which may be subject to change. Please see pages 134-135 for explanation on Recommended On-The-Road (OTR) retail prices and VED rates.

A4 SE

Available as Saloon or Avant.



1.



2.



3.



4.

Main image. A4 Saloon SE in optional Manhattan grey, metallic (H1). 1. 17" '10-spoke crystal' design alloy wheels. 2. Xenon headlights with LED daytime-running lights. Image also shows revised air inlet design when Adaptive cruise control is ordered. 3. Standard seats in Concept cloth. 4. Deluxe 3-zone electronic climate control.



5.



6.



7.



8.

Main image. A4 Avant in optional Manhattan grey, metallic (H1). 5. 3-spoke leather trimmed multi-function steering wheel with paddles for automatic transmissions. 6. MMI Radio Plus with 7" colour MMI screen and Audi Smartphone Interface. 7. Audi Drive Select. 8. MMI controller with integrated joystick function.

A4 Sport

Specification in addition to SE.

The Sport trim builds off the same premium specification as SE with exterior styling upgrades for an enhanced sporty look. Inside, you gain MMI Navigation and an automatic 3-month subscription to Audi Connect Infotainment Services. Sport seats, a Sport steering wheel and the 180-watt Audi Sound System are also among the additional benefits.

Wheels

- ▶ 17" '5-spoke Y' design alloy wheels
- ▶ ultra TDI models come with low rolling resistance tyres

Exterior equipment

- ▶ Radiator grille in Twilight grey matt with chrome inlays
- ▶ Air inlets in Titan black with 2 horizontal inlays in chrome
- ▶ Rear diffuser in Twilight grey matt
- ▶ Door handles in body colour

Seats

- ▶ Front Sport seats in System cloth

Interior equipment

- ▶ 3-spoke leather multi-function Sport steering wheel
- ▶ LED Interior Lighting Pack

Audio and communication

- ▶ MMI Navigation with 7" colour MMI screen
- ▶ 3D map display
- ▶ MMI search
- ▶ 2x SDXC card readers
- ▶ Audi Sound System with 10 loudspeakers
- ▶ Audi Connect Infotainment Services (3-month trial)^

	Petrol				Diesel
Engine	1.4 TFSI	2.0 TFSI	2.0 TFSI	2.0 TFSI quattro	2.0 TDI ultra
Power	150PS	190PS	190PS	252PS	150PS
Transmission	6-speed manual	6-speed manual	7-speed S tronic	7-speed S tronic	6-speed manual
Saloon					
CO₂g/km*	126	127	116	136	99
RRP inc VAT**	£26,615	£28,415	£29,945	£35,295	£29,865
Recommended OTR**	£27,300	£29,100	£30,630	£36,110	£30,550
Avant					
CO₂g/km*	131	132	121	139	104
RRP inc VAT**	£28,015	£29,685	£31,345	£36,695	£31,265
Recommended OTR**	£28,830	£30,500	£32,030	£37,510	£31,950

Diesel					
2.0 TDI ultra	2.0 TDI ultra	2.0 TDI ultra	2.0 TDI quattro	3.0 V6 TDI	3.0 V6 TDI quattro
150PS	190PS	190PS	190PS	218PS	218PS
7-speed S tronic	6-speed manual	7-speed S tronic	7-speed S tronic	7-speed S tronic	7-speed S tronic
CO₂g/km*	101	102	103	114	109
RRP inc VAT**	£31,395	£30,765	£32,295	£33,725	£34,015
Recommended OTR**	£32,080	£31,450	£32,980	£34,410	£34,700
CO₂g/km*	104	106	106	116	114
RRP inc VAT**	£32,795	£32,165	£33,695	£35,125	£35,415
Recommended OTR**	£33,480	£32,850	£34,380	£35,810	£36,100

For more details on the items listed above, please see the Glossary on pages 114-117. *Standard EU test figures for comparative purposes and may not reflect real driving results. Optional alloy wheels may also affect CO₂ emissions and fuel consumption figures. This may lead to a change to the VED amount payable. Please refer to pages 66-67, 120-121, 124-125 and 135. Values based on standard EU test figures for comparative purposes and may not reflect real driving results. **RRP including VAT, includes VAT at 20%, which may be subject to change. Please see pages 134-135 for explanation on Recommended On-The-Road (OTR) retail prices and VED rates.

A4 Sport

Available as Saloon or Avant.



1.



2.



3.



4.

Main image. A4 Avant Sport in optional Scuba blue, metallic (S9). 1. 17" '5-spoke Y' design alloy wheels. 2. Radiator grille in Twilight grey matt with chrome inlays. 3. Air inlets in Titan black with two horizontal inlays in chrome. 4. Rear diffuser in Twilight grey matt.



5.



6.



7.



8.

Main image. A4 Saloon Sport in optional Scuba blue, metallic (S9). 5. Front Sport seats in System cloth in Black/Red. 6. Inlays in Aluminium Ellipse, silver. 7. 3-spoke leather multi-function Sport steering wheel. 8. MMI Navigation with 7" colour MMI screen.

A4 S line

Specification in addition or replacement to Sport.

Designed with the most driving-focused owners in mind, the S line specification includes an upgrade to a larger 18” alloy wheel, and visual enhancements courtesy of bespoke S line exterior styling. It stands out on the road with LED headlights, incorporating LED daytime-running lights and LED rear lights with dynamic rear indicators. Sport seats upholstered in a combination of cloth and leather help to set the tone inside, and Sport suspension does the same for the driving experience.

Wheels

- ▶ 18” ‘5-twin-spoke Star’ design alloy wheels

Lighting

- ▶ LED headlights with LED rear lights and dynamic rear indicators
- ▶ Side air inlet grille in Titan black matt with chrome inlays in unique S line design
- ▶ Rear diffuser in Twilight grey matt
- ▶ Rear grille, black grained
- ▶ S line badges on the front wings
- ▶ S line roof edge spoiler (Avant models only)

Performance and suspension

- ▶ Sport suspension – lowered by 20mm

Exterior equipment

- ▶ S line front and rear bumpers and side skirts
- ▶ Radiator grille in Twilight grey matt with chrome inlays

Seats

- ▶ Front Sport seats with ‘S’ embossed logo
- ▶ Sprint cloth/leather
- ▶ 4-way electric lumbar support

Interior equipment

- ▶ S line 3-spoke leather multi-function Sport steering wheel, grips in perforated leather (and paddles for automatic transmissions)
- ▶ Gear-lever knob in black perforated leather
- ▶ Illuminated door sill trims with S logo
- ▶ Pedals and footrest in stainless steel
- ▶ Headlining in black cloth
- ▶ Contrast stitching on seats, steering wheel and gear-lever gaiter

Inlays

- ▶ Inlays in Matt brushed aluminium

	Petrol			Diesel		
	2.0 TFSI	2.0 TFSI	2.0 TFSI quattro	2.0 TDI	2.0 TDI	2.0 TDI ultra
Engine						
Power	190PS	190PS	252PS	150PS	150PS	190PS
Transmission	6-speed manual	7-speed S tronic	7-speed S tronic	6-speed manual	7-speed S tronic	6-speed manual
Saloon						
CO ₂ g/km*	130	119	141	106	109	107
RRP inc VAT**	£29,865	£31,395	£36,745	£31,315	£32,845	£32,215
Recommended OTR**	£30,550	£32,080	£37,575	£32,000	£33,530	£32,900
Avant						
CO ₂ g/km*	135	124	144	111	112	111
RRP inc VAT**	£31,135	£32,795	£38,145	£32,715	£34,245	£33,615
Recommended OTR**	£31,950	£33,480	£38,975	£33,400	£34,930	£34,300

Diesel						
2.0 TDI ultra	2.0 TDI	2.0 TDI	2.0 TDI quattro	3.0 V6 TDI	3.0 V6 TDI quattro	3.0 V6 TDI quattro
190PS	190PS	190PS	190PS	218PS	218PS	272PS
7-speed S tronic	6-speed manual	7-speed S tronic	7-speed S tronic	7-speed S tronic	7-speed S tronic	8-speed tiptronic
109	113	111	118	114	123	134
£33,745	£32,215	£33,745	£35,175	£35,465	£36,895	£38,665
£34,430	£32,900	£34,430	£35,860	£36,150	£37,580	£39,480
112	116	113	120	117	126	139
£35,145	£33,615	£35,145	£36,575	£36,865	£38,295	£40,065
£35,830	£34,300	£35,830	£37,260	£37,550	£38,980	£40,880

For more details on the items listed above, please see the Glossary on pages 114-117. *Standard EU test figures for comparative purposes and may not reflect real driving results. Optional alloy wheels may also affect CO₂ emissions and fuel consumption figures. This may lead to a change to the VED amount payable. Please refer to pages 66-67, 120-121, 124-125 and 135. Values based on standard EU test figures for comparative purposes and may not reflect real driving results. **RRP including VAT, includes VAT at 20%, which may be subject to change. Please see pages 134-135 for explanation on Recommended On-The-Road (OTR) retail prices and VED rates.

A4 S line

Available as Saloon or Avant.



1.



2.



3.



4.

Main image. A4 Saloon S line in optional Tango red, metallic (Y1). 1. 18" '5-twin-spoke Star' design alloy wheels. 2. LED headlights. 3. Radiator grille in Twilight grey matt with chrome inlays. 4. Rear diffuser in Twilight grey matt.



5.

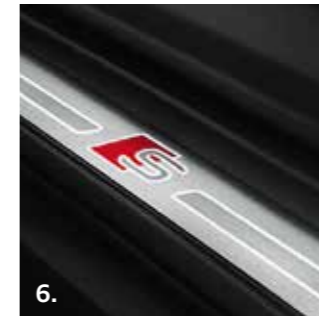

6.



7.



8.

Main image. A4 Avant S line in optional Tango red, metallic (Y1). 5. Front Sport seats with embossed S logo. 6. Illuminated door sill trims with S logo. 7. S line 3-spoke leather multi-function Sport steering wheel. 8. Inlays in Matt brushed aluminium.

S4

Specification in addition or replacement to S line.

Enhanced brakes and suspension. A significantly more powerful engine. Unique S4 exterior styling. Every feature of the Audi S4 is chosen to deliver an engaging and exhilarating drive. And with a high level of standard equipment offering the best in technology and comfort, it's the pinnacle of the A4 range.

Wheels

- ▶ 18" '5-V spoke' design alloy wheels in matt black, diamond cut finish

Performance and suspension

- ▶ 'S' Sport suspension
- ▶ 'S' model enhanced braking system

Lighting

- ▶ High-beam assist
- ▶ Headlight washers

Exterior equipment

- ▶ 'S' radiator grille in Twilight grey matt with dual struts in aluminium and S4 logo
- ▶ 'S' specific side air inlets in Titan black with chrome inlays in unique 'S' design
- ▶ 'S' rear diffuser in Twilight grey matt and honeycomb grid in black
- ▶ Rear spoiler
- ▶ 'S' specific dual-branch chrome tailpipes, with twin oval pipes on both the left and right
- ▶ Brake calipers painted in black with S4 logo at the front
- ▶ Aluminium-effect door mirror housings
- ▶ Door handles with chrome trim

Seats

- ▶ Front 'S' Super Sport seats, electrically adjustable with 'S' embossed logo
- ▶ Fine Nappa leather upholstery
- ▶ Lumbar support, pneumatically adjustable with massage function
- ▶ Heated front seats

Interior equipment

- ▶ 'S' instrument dials
- ▶ Extended Interior Upholstery Pack
- ▶ High multi-function 3-spoke leather multi-function Sport steering wheel with 'S' badging and paddles
- ▶ Gear-lever with diamond 'S' badge
- ▶ Gear-lever knob in black leather
- ▶ Key with S4 logo

Audio and communication

- ▶ MMI Navigation Plus with 8.3" high-resolution colour screen
- ▶ MMI Touch control panel
- ▶ Audi Connect Infotainment Services (36-month subscription)
- ▶ Driver Information System – 7" colour display

3.0 V6 TFSI quattro engine

To achieve the very highest performance, the Audi S4 features the new 3.0 TFSI engine in the 6-cylinder design, this supercharged unit delivers up to 354PS, 500 Nm of torque and a top speed of up to 155mph.* And it channels all that power through our legendary quattro all-wheel drive system for impressive road-holding and control.



	Saloon	Avant
Engine	3.0 V6 TFSI quattro	3.0 V6 TFSI quattro
Transmission	8-speed tiptronic	8-speed tiptronic
Power	354PS	354PS
CO ₂ g/km*	166	171
RRP inc VAT**	£43,015	£44,415
Recommended OTR**	£44,000	£45,400

For more details on the items listed above, please see the Glossary on pages 114-117. *Standard EU test figures for comparative purposes and may not reflect real driving results. Optional alloy wheels may also affect CO₂ emissions and fuel consumption figures. This may lead to a change to the VED amount payable. Please refer to pages 66-67, 127 and 135. Values based on standard EU test figures for comparative purposes and may not reflect real driving results.

**RRP including VAT, includes VAT at 20%, which may be subject to change. Please see pages 134-135 for explanation on Recommended On-The-Road (OTR) retail prices and VED rates. *Where law permits.

S4

Available as Saloon or Avant.



1.



2.



3.



4.

Main image. S4 Saloon in optional Navarra blue, metallic (2D). 1. 18" '5-V spoke' design alloy wheels in matt black, diamond cut finish. 2. LED headlights. 3. Aluminium look door mirrors. 4. 'S' rear diffuser in Twilight grey matt and honeycomb grid in black.



5.

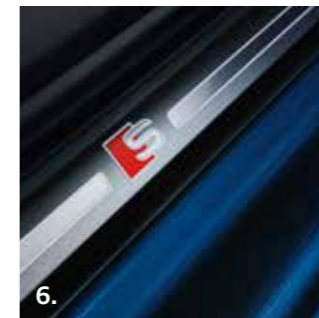

6.



7.













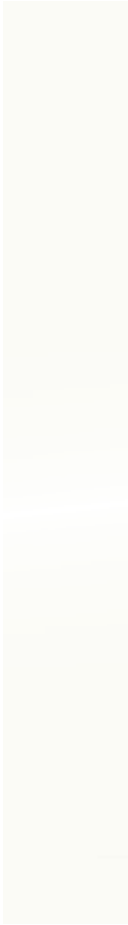



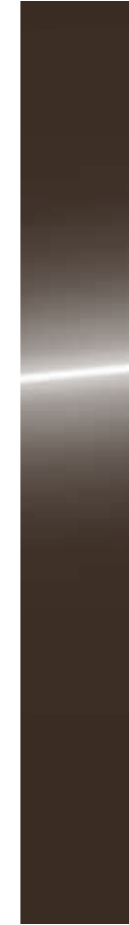

8.

Main image. S4 Avant in optional Navarra blue, metallic (2D). 5. Front 'S' Super Sport Seats in Fine Nappa leather with embossed 'S' logo. 6. Illuminated door sill trims with S logo. 7. MMI Navigation Plus with 8.3" colour screen. 8. MMI Touch control panel.

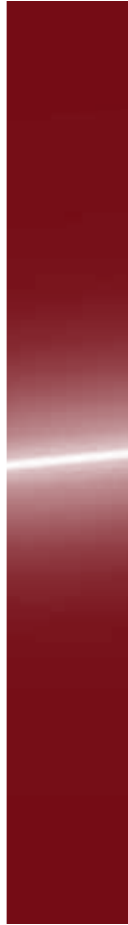
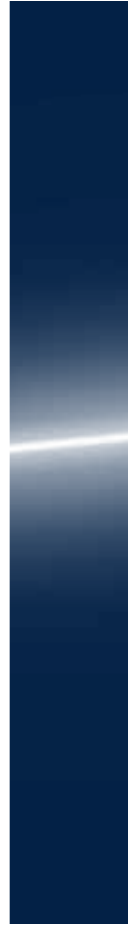
Paint

Available in a choice of standard and optional colours.

Choose from a selection of two standard or 12 optional paint colours. S line and S4 models both have the additional colour choice of Daytona grey whilst S4 gets two more colours Navarra blue and Misano red. For more specialist options, Audi exclusive will be available in 2016. Please contact your local Audi Centre for details.

Standard colours Available on all models		Optional colours £645							Optional colours £645					S line and S4 colour Available on S line and S4 models only £645	S4 colours Available on S4 models only £645		Audi exclusive available soon.
																	
Ibis white, solid, T9	Brilliant black, solid, A2	Glacier white, metallic, 2Y	Cuvée silver, metallic, 0D*	Floret silver, metallic, L5	Manhattan grey, metallic, H1	Monsoon grey, metallic, 0C*	Mythos black, metallic, 0E	Argus brown, metallic, W3*	Gotland green, metallic, Q6	Tango red, metallic, Y1	Matador red, metallic, T7*	Scuba blue, metallic, S9*	Moonlight blue, metallic, W1*	Daytona grey, pearl effect, 6Y	Navarra blue, metallic, 2D	Misano red, pearl effect, N9	Audi exclusive available soon.

All pricing is RRP including VAT at 20%. Options are subject to availability and may extend time taken for delivery. *Not available on S4.

All the colour swatches on this page are matched as accurately as possible to the actual paint colours used. However, due to print processes, Audi UK cannot guarantee that colours shown are 100% accurate. Visit your local Audi Centre for a more accurate colour swatch.

Wheels

Enhance your style.

Whatever your taste, there's a set of alloy wheels that will add the final flourish.

Tyre information

All 17" wheels supplied with:
17" x 7.5J 225/50 R17 tyres.

All 18" wheels supplied with:
18" x 8.0J 245/40 R18 tyres.

All ultra TDI models are only available with 17" and 18" alloy wheels and come with low rolling resistance tyres.

All 19" wheels supplied with:
19" x 8.5J 245/35 R19 tyres.

All pricing is RRP including VAT at 20%.

Options are subject to availability and may extend time taken for delivery.

Please note that the size of your chosen wheel may affect the fuel consumption figures and the CO₂ emissions. This may result in a change in subsequent Vehicle Excise Duty payable. Please see pages 120-121, 124-125, 127 and 135 for details.



17" '10-spoke crystal' design alloy wheels

C8F	SE	Standard
-----	----	----------



17" '5-spoke Y' design alloy wheels

C4N	Sport	Standard
-----	-------	----------



18" '10-spoke V' design alloy wheels

PRD	SE	£700
	Sport	£700



18" '5-twin-spoke' design alloy wheels, diamond cut finish

PRJ	SE	£850
	Sport	£850



18" '5-twin-spoke' design alloy wheels

PQG	Sport	£1,200
-----	-------	--------



17" '5-arm tornado' design alloy wheels

PRF	SE	£250
	Sport	£250



17" '5-arm star' design alloy wheels

PRE	SE	£250
	Sport	£250



18" '5-twin-spoke star' design alloy wheels

PRB	S line	Standard
-----	--------	----------



18" '5-spoke dynamic' design alloy wheels, diamond cut finish

PRA	S line	£150
-----	--------	------



18" '5-V spoke' design alloy wheels in matt black, diamond cut finish

U46	S4	Standard
-----	----	----------

17" alloy wheels

18" alloy wheels

19" alloy wheels



17" '5-parallel spoke' design alloy wheels

PRH	SE	£250
	Sport	£250



19" '10-V spoke' design alloy wheels

PQ5	S line	£900
	S4	£275



19" '5-V spoke' design alloy wheels in matt titanium look, diamond cut finish

PQI	S line	£1,200
	S4	£550



19" x 8.5J '5-spoke V' design alloy wheels, contrasting grey diamond cut finish

PQJ	S4	£1,200
-----	----	--------

Performance and suspension

Options for ultimate handling, comfort and agility.

Sport suspension

Lowered by 20mm compared to Comfort Dynamic suspension, with stiffer suspension and damping for more direct contact with the road and sportier handling.

Adaptive Comfort suspension with damping control

Electronically regulated suspension system which offers maximum ride comfort. Suspension is lowered by 10mm and adjusts to different driving situations. Dynamic or comfort-oriented characteristics for shock absorber settings adjusted via Audi Drive Select.

Adaptive 'S' Sport suspension with damping control

Electronically regulated suspension system which offers the ultimate sport ride for S4 models. Suspension is lowered by 20mm (as with 'S' Sport suspension) and adjusts to different driving situations. Provides sportier response with improved comfort. Dynamic or comfort-oriented characteristics for shock absorber settings adjusted via Audi Drive Select.

Dynamic steering

Enhances driving dynamics and ride comfort by regulating the steering according to the driving situation. With this technology, driving is significantly more agile under everyday conditions, while directional stability and precision are increased at high speeds and in demanding driving situations.

Adaptive Sport suspension with damping control

Electronically regulated suspension system which offers the sportiest ride at the same time as improving comfort. Suspension is lowered by 20mm (as with Sport suspension) and adjusts to different driving situations. Dynamic or comfort-oriented characteristics for shock absorber settings adjusted via Audi Drive Select.

quattro with Sport differential

The electronically regulated Sport differential distributes variable amounts of driving force to each rear wheel, improving stability and agility, especially when cornering. It ensures better direct steering characteristics and, thanks to less steering effort, more agile handling.

		SE	Sport	S line	S4
1BA	Comfort Dynamic suspension. Not available on TDI ultra models	Standard	Standard	No charge	Not available
1BE	Sport suspension. Standard on all TDI ultra models	Not available	£325	Standard	Not available
1N8	Dynamic steering	£950	£950	£950	£950
1BL	Adaptive Comfort suspension with damping control. Not available on TDI ultra models	£900	£900	£600	Not available
1BQ	Adaptive Sport suspension with damping control	£900	£900	£600	Not available
2MV	Adaptive 'S' Sport suspension with damping control	Not available	Not available	Not available	£900
GH2	quattro with Sport differential	Not available	Not available	Not available	£1,200



Image shows A4 S line with standard 18" '5-twin-spoke star' design alloy wheels with Sport suspension (1BE)



1.



2.



3.



4.

1. Matrix LED headlights with LED rear lights and dynamic front and rear indicators (PXC). 2. Dynamic rear indicators (PXC or PX2). 3. Headlight washers (8X1). 4. LED headlights with LED rear lights and dynamic rear indicators (PX2).

Lighting

Advanced headlights that adapt to the road.

Matrix LED headlights with LED rear lights and dynamic front and rear indicators

Audi Matrix LED technology provides precise illumination of the road whilst reducing the risk of dazzling other road users. Using information from the vehicle's sensors, camera and MMI Navigation (if equipped), Matrix LED calculates the appropriate lighting required and automatically dips or turns off individual lighting diodes, creating corridors of lights either side of the vehicle or the object in front of it. Includes dynamic front and rear indicators which sweep from inside to out. This helps to clearly identify not only that the vehicle is turning, but in which direction.

LED headlights with LED rear lights and dynamic rear indicators

All-weather headlights with dynamic headlight adjustment and dipped beam, high beam, indicators and turning light in LED technology. Enables a near daylight illumination of the road, minimum energy consumption and long service life. Includes dynamic rear indicators which sweep from inside to out. This helps to clearly identify not only that the vehicle is turning, but in which direction.

High-beam assist

Within system limits, High-beam assist detects the headlights of oncoming traffic, the rear lights of other road users and light sources in built-up areas. Depending on the traffic situation, the high beam automatically adjusts to dipped beam and vice versa. The system improves the driver's visibility and ensures a more relaxed drive thanks to the extra comfort and convenience.

		SE	Sport	S line	S4
PXC	Matrix LED headlights with LED rear lights and dynamic front and rear indicators. Also available in Light and Vision Pack (WB7, 9S8)	£1,750	£1,750	£650	£650
PX2	LED headlights with LED rear lights and dynamic rear indicators.	£1,050	£1,050	Standard	Standard
8G1	High-beam assist. Also available in Vision Pack (WB6, 9S8). Not available in combination with Matrix LED headlights (PXC) or Light and Vision Pack (WB7, 9S8)	£150	£150	£150	Standard
8X1	Headlight washers. For excellent illumination and improved visibility	£250	£250	£250	Standard

Exterior Styling Pack

Extended Black Styling Pack

This pack adds striking 19" alloy wheels and privacy glass, as well as gloss black door mirror housings. The radiator grille and frame, front and rear air intakes, and window trims are also enhanced with black accents. On Avant models only, the roof rails are also in black.

19" '5-V spoke' design alloy wheels in matt titanium look, diamond cut finish.

Black Styling Pack.

Black accents in the following areas: Radiator grille and frame, front and rear air intakes and window trims. Design varies depending on model and equipment. Also includes door mirror housings in gloss black and Avant models additionally include black roof rails.

Privacy glass and front acoustic glazing (side and rear windows).

Dark-tinted rear and rear-side windows (from B-pillar backwards) and front side windows in acoustic glass for better insulation from exterior noise.



19" '5-V spoke' design alloy wheels



Black radiator grille and frame



Privacy glass, black window trims and door mirror housings

	SE	Sport	S line	S4
WBO, PQI	Extended Black Styling Pack			
	Not available	Not available	£1,200	Not available



Image shows A4 Saloon S line with optional Tango red, metallic paint (Y1) and Extended Black Styling Pack (WBO, PQI)

Exterior equipment

Options for added style and convenience.

Black Styling Pack

Enhance the sportiness of your A4 with black accents in the following areas: radiator grille and frame, front and rear air intakes, and window trims. Design varies depending on model and equipment. Also includes door mirror housings in gloss black (6FJ) and Avant models additionally include black roof rails (3S2).

Door mirrors (folding)

Electrically folding, adjustable and heated with built-in LED side indicators and kerb-view function for passenger side.

Door mirrors (folding with memory function)

Electrically folding with memory function. Electrically adjustable and heated with built-in LED side indicators and kerb-view function for passenger side.

Door mirrors (folding with auto-dimming and memory function)

Auto-dimming with memory function, electrically folding, adjustable and heated with built-in LED side indicators and kerb-view function for passenger side.

		SE	Sport	S line	S4
4ZD, 6FJ	Black Styling Pack	Not available	£550	£550	£550
6XE	Door mirrors (folding)	£225	£225	£225	£225
6XF	Door mirrors (folding with memory function). Only available in combination with electrically adjustable front seats (PV3 or PS8)	£225	£225	£225	£225
6XL	Door mirrors (folding with auto-dimming and memory function). Only available in combination with electrically adjustable front seats (PV3 or PS8)	£325	£325	£325	£325
PC2	Red brake calipers	Not available	Not available	Not available	£300
OM1	Fuel tank 54 litres. Available as an option on 2.0 TDI models, to increase fuel tank from 40 to 54 litres. All 3.0 TDI and TFSI engines come as standard with 54 litre tank. All 2.0 and 3.0 quattro variants have a 58 litre tank	No charge	No charge	No charge	Not available
FK2	AdBlue® tank 24 litres. Available as an option on all TDI models, to increase AdBlue® tank from 12 to 24 litres. Not applicable to TFSI engines. On TDI ultra models, only available in combination with Fuel tank 54 litres (OM1)	No charge	No charge	No charge	Not available



Image shows A4 Avant S line with optional Audi exclusive Sprint blue, pear-effect paint, Black Styling Pack (4ZD, 6FJ), 19" '10-spoke-V' alloy wheels (PQ5), Matrix LED headlight with LED rear lights and dynamic front and rear indicators (PXC) and Driver Assistance Pack Tour (PCN)

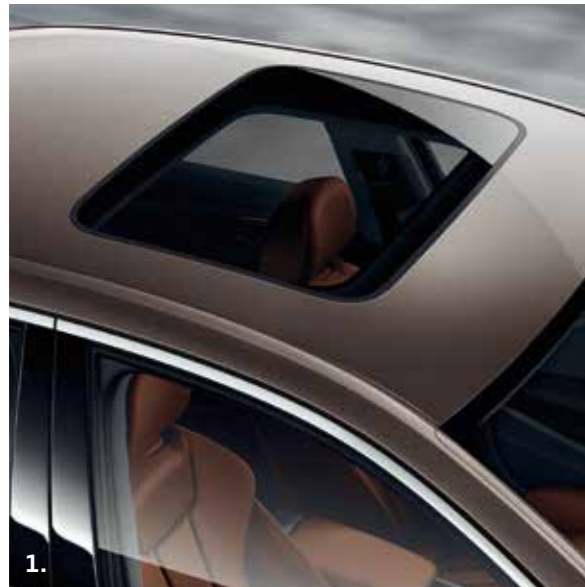

1.



2.



3.



3.

1. Electric slide and tilt sunroof (3FE). 2. Panoramic glass sunroof (3FU).
3. Privacy glass and front acoustic glazing (VW6). 4. Image shows tow bar, folding (1D4).

Exterior equipment

Innovative options for added style and convenience.

Electric slide and tilt sunroof

Available on Saloon models, this sunroof comprises of a single glass section, which raises and opens electrically. Includes a manually adjustable sunshield and convenience closing via the central locking remote control.

Panoramic glass sunroof

Available on Avant models, the panoramic glass sunroof comprises of two tinted glass sections. The front glass section raises and opens electrically. Includes an electrically adjustable sunshield and convenience closing via the central locking remote control. The integrated wind deflector reduces wind noise when the roof is open.

Privacy glass and front acoustic glazing

Dark-tinted rear and rear-side windows (from B-pillar backwards) and front side windows in acoustic glass for better insulation from exterior noise.

Tow bar (folding)

Manually swivelling ball head with electric release. Operated via a button in the luggage compartment. Includes trailer/caravan stabilisation via Electronic Stability Control (ESC) and allows continual use of electrical devices in the trailer/caravan whilst driving. 13- to 7-pin adaptor may be required – please ask for details and pricing at your local Audi Centre.

		SE	Sport	S line	S4
3FE	Electric slide and tilt sunroof. Only available on Saloon models	£950	£950	£950	£950
3FU	Panoramic glass sunroof. Only available on Avant models	£1,250	£1,250	£1,250	£1,250
VW6	Privacy glass and front acoustic glazing	£450	£450	£450	£450
1D4	Tow bar (folding)	£850	£850	£850	£850
2Z0	Deletion of model and technology designation at rear	No charge	No charge	No charge	No charge
2Z7	Deletion of engine technology designation at rear	No charge	No charge	No charge	Not available

A4 SE seat colours and trim

Standard seats

Concept cloth (N1N) standard on SE

Although referred to as standard, there really is nothing ordinary or standard about this seat. Comfortable, stylish and available in a choice of Black or Rock grey Concept cloth. Seat functionality includes manual adjustment for seat forwards/backwards position, backrest angle, head restraint and seat belt height. Concept cloth in the following areas: seat upholstery, head restraints, front centre armrest and door trim inserts.

Twin leather (N1F) optional on SE £850

A new combination trim offering the comfort and style of leather without the higher cost. For maximum durability, real leather is applied in the following areas: seat centre panels on the front seats, driver's seat bolster (entrance side only) and seat centre panels on the two outer rear seats. Leatherette trim is applied on the head restraints, seat side bolsters, door trim inserts, centre armrest and middle rear seat. Available in a choice of four leather colours as shown on page 79.

Milano leather (N5W) optional on SE £1,350

High-quality and long lasting leather with a fine grain appearance. Milano leather is in the following areas: entire seat including head restraints and centre armrest. Door trim inserts are in leatherette. Available in a choice of four leather colours as shown on page 79.



Concept cloth
N1N Standard on SE



Upholstery	Black - YM	Rock grey - ZG
Headlining	Titanium grey	Titanium grey
Dashboard (upper/lower)	Black/Black	Granite grey/Rock grey
Carpet	Black	Granite grey

A4 SE optional colours and trim

Standard seats with optional upholstery finishes.

Upgrade the upholstery on your Standard seat by choosing either Twin leather or Milano leather. Both available in a choice of four colours, with Rock grey and Atlas beige additionally available with a two-tone dashboard.

Twin leather
N1F Optional on SE
£850



Milano leather
N5W Optional on SE
£1,350

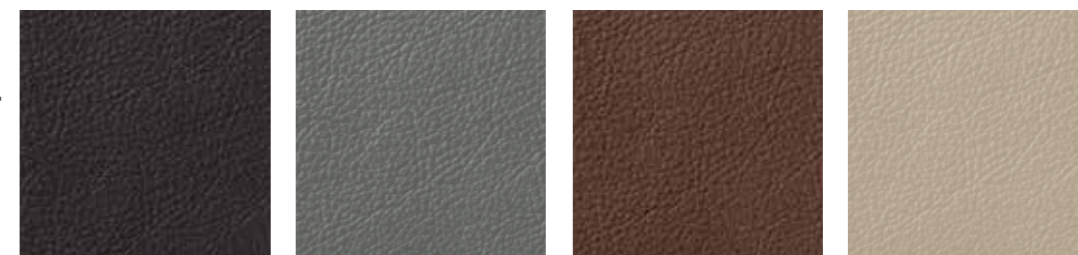

Upholstery	Black - YM	Rock grey - ZF	Nougat brown - ZK	Atlas beige - ZE
Headlining	Titanium grey	Titanium grey	Titanium grey	Titanium grey
Dashboard (upper/lower)	Black/Black	Black/Black	Black/Black	Black/Black
Carpet	Black	Black	Black	Black
Upholstery	Rock grey - ZG		Atlas beige - ZI	
Headlining	Titanium grey		Atlas beige	
Dashboard (upper/lower)	Granite grey/Rock grey		Granite grey/Atlas beige	
Carpet	Granite grey		Granite grey	

Image shows a Standard seat with optional 4-way electric lumbar support (7P1). All colour swatches on this page are matched as accurately as possible to the actual upholstery colours used. However, due to print processes, Audi UK cannot guarantee that the colours shown are 100% accurate. Visit your local Audi Centre for a more accurate colour swatch.

All pricing is RRP including VAT at 20%. Options are subject to availability and may extend time taken for delivery.



Image shows A4 Sport with Sport seat in System cloth in Black/Red (AH)

A4 Sport seat colours and trim

Sport seats

System cloth (N2E) standard on Sport

The interior of the new A4 Sport trim has the styling credentials to complement the exterior. The seats not only have a sport design, they also offer a firmer and more supported driving style with extended thigh support and prominent side bolsters which improve lateral support. Available as standard in a choice of full black or black/red System cloth. Seat functionality includes manual adjustment for seat height, seat forwards/backwards position, backrest angle, head restraint and seat belt height. System cloth in the following areas: seat upholstery, thigh supports, head restraints, front centre armrest and door trim inserts.

Twin leather (N1F) optional on Sport £850

A new combination trim offering the comfort and style of leather without the higher cost. For details on Twin leather and where it is applied please see page 78. Available in a choice of three leather colours as shown on page 82.

Leather/Alcantara (N7U) optional on Sport £1,150

The addition of Alcantara upholstery with leather enhances the style of your seats, offers additional grip for sportier driving and at the same time offers added comfort across the seasons. Seat centre, shoulder panels and door trim inserts in Alcantara. Seat side bolsters, head restraints and front centre armrests in leather complete the look. Available in a choice of two leather colours as shown on page 82.

Milano leather (N5W) optional on Sport £1,350

High-quality and long lasting leather with fine grained appearance. For details on Milano leather and where it is applied please see page 78. Available in a choice of four leather colours as shown on page 82.



System cloth
N2E Standard on Sport

Upholstery	Black - YM	Black/Red - AH
Headlining	Titanium grey	Titanium grey
Dashboard (upper/lower)	Black/Black	Black/Black
Carpet	Black	Black

Image above shows a Sport seat with Climate function (PS8) and with optional Electrical adjustment (3L5) and 4-way electric lumbar support (7P1). For an image of a Standard front Sport seat see page 80. All pricing is RRP including VAT at 20%. Options are subject to availability and may extend time taken for delivery. Visit your local Audi Centre for a more accurate colour swatch. All colour swatches are matched as accurately as possible to the actual upholstery colours used. However, due to print processes, Audi UK cannot guarantee that the colours shown are 100% accurate.

A4 Sport optional colours and trim

Sport seats with optional upholstery finishes.

Twin leather
N1F **Optional on Sport**
£850



**Leather/
Alcantara**
N7U **Optional on Sport**
£1,150

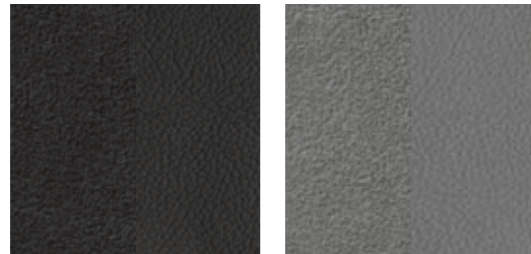

Milano leather
N5W **Optional on Sport**
£1,350

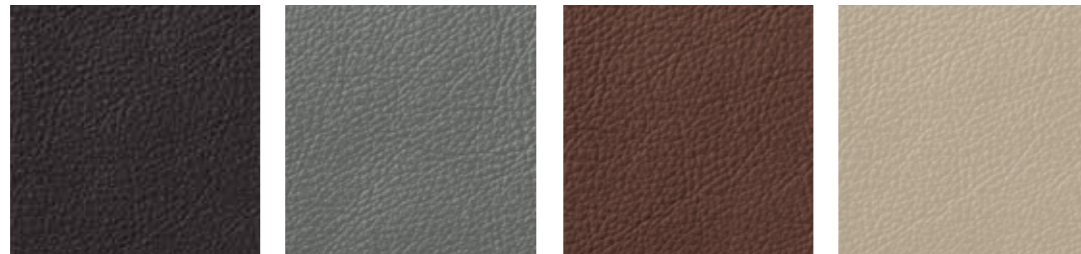

Upholstery	Black – YM	Rock grey – ZF*	Nougat brown – ZK	Atlas beige – ZE
Headlining	Titanium grey	Titanium grey	Titanium grey	Titanium grey
Dashboard (upper/lower)	Black/Black	Black/Black	Black/Black	Black/Black
Carpet	Black	Black	Black	Black
Upholstery	Rock grey – ZG		Atlas beige – ZI	
Headlining	Titanium grey		Atlas beige	
Dashboard (upper/lower)	Granite grey/Rock grey		Granite grey/Atlas beige	
Carpet	Granite grey		Granite grey	

*Not available on leather/Alcantara.

All colour swatches on this page are matched as accurately as possible to the actual upholstery colours used. However, due to print processes, Audi UK cannot guarantee that the colours shown are 100% accurate.

Visit your local Audi Centre for a more accurate colour swatch.

A4 Sport optional colours and trim

Climate function for Front Sport seats PS8

Optional on Sport

To maximise seat comfort in hot weather, the climate function option provides active ventilation for the seat and backrest centre sections of the driver and front passenger seats. Three different cooling intensities are available and operated via the climate control panel. Includes the added functionality of electric 4-way lumbar support (7P1). To allow for ventilation, the seat centre panels are perforated. The outer rear seats are also perforated to match, but are not ventilated.

Only in combination with Twin leather (N1F) or Milano leather (N5W) and with the following chargeable options: Heated seats (4A3 or 4A4) and Electrically adjustable front seats (3L5 or PV3). Please note: these seats have a unique design compared to standard Front Sport seats – see page 81.

**Climate
function with
Twin leather**
N1F **Optional on Sport**
£1,600

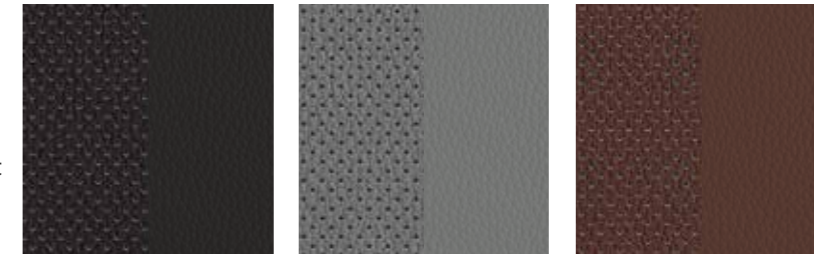

**Climate
function with
Milano leather**
N5W **Optional on Sport**
£2,100



Upholstery	Black – YM	Rock grey – ZF	Nougat brown – ZK
Headlining	Titanium grey	Titanium grey	Titanium grey
Dashboard (upper/lower)	Black/Black	Black/Black	Black/Black
Carpet	Black	Black	Black
Upholstery	Rock grey – ZG		
Headlining	Titanium grey		
Dashboard (upper/lower)	Granite grey/Rock grey		
Carpet	Granite grey		

All pricing is RRP including VAT at 20%. Options are subject to availability and may extend time taken for delivery.



Image shows A4 S line with optional Fine Nappa leather (N3M) and Light and Vision Pack (WB7, 958)

A4 S line seat colours and trim

Front Sport seats with S embossed logo

Sprint cloth/leather (N7V) standard on S line

Unique to the S line, standard Front Sport seats with Sprint cloth/leather upholstery come with 'S' embossing on the front seat backs and the added functionality of electric 4-way lumbar support. The seats not only have a sporty design but also offer a firmer and more supported driving style with extended thigh support and prominent side bolsters which improve lateral support. Seat functionality includes manual adjustment for seat height, seat forwards/backwards position, backrest angle, head restraint and seat belt height. Seat centre, shoulder panels and door trim inserts in cloth. Seat side bolsters, head restraints and front centre armrest in leather. Enhanced with contrast stitching in the following areas: seats, steering wheel, gear lever, armrest and floor mats.

Leather/Alcantara (N7K) optional on S line £450

Unique to S line, Alcantara with an embossed pattern and contrast stitching enhances the styling of your seats, offers additional grip for sportier driving and at the same time provides added comfort across the seasons. Seat centre, shoulder panels and door inserts in Alcantara. Seat side bolsters, head restraint and front centre armrest in leather.

Fine Nappa leather (N3M) optional on S line £1,250

Upgrade S line seats to the highest quality, supple Fine Nappa leather which is breathable, durable and features a natural fine grain. Seat upholstery, head restraints, and front centre armrest in Fine Nappa leather. Door trim inserts in Alcantara.

Sprint cloth/leather

N7V Standard on S line

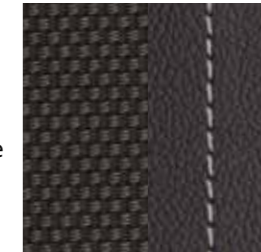

Leather/Alcantara

N7K Optional on S line
£450



Fine Nappa leather

N3M Optional on S line
£1,250



Upholstery	Black - EI	Rotor grey - 0Q
Headlining	Black	Black
Dashboard (upper/lower)	Black/Black	Black/Black
Carpet	Black	Black

All pricing is RRP including VAT at 20%. Options are subject to availability and may extend time taken for delivery. Visit your local Audi Centre for a more accurate colour swatch. All colour swatches are matched as accurately as possible to the actual upholstery colours used. However, due to print processes, Audi UK cannot guarantee that the colours shown are 100% accurate.



Image shows S4 with Front S Super Sport seats in Black Fine Nappa leather (EI)

S4 seat colours and trim

S Super Sport seats with S embossed logo

Fine Nappa leather (N3M) standard on S4

S Super Sport seats are standard on S4 and offer luxury with a distinctive sporty design. These seats come with integrated head rests and Fine Nappa leather enhanced with diamond stitching and 'S' embossing on the front seat backs. The pronounced side bolsters and thigh extensions offer improved lateral support whilst the pneumatic lumbar with massage function provides added comfort with optimum support to the lumbar area with targeted inflation/deflation using 3 inflatable lumbar bolsters. Also includes massage function which is controlled via MMI or the multifunction switch on the seat. Seat functionality includes electric adjustment of seat height, forwards/backwards position, seat angle, backrest angle and manual adjustment of belt height.

Fine Nappa leather N3M Standard on S4



Upholstery	Black - EI	Rotor grey - OQ	Magma red - AU
Headlining	Black	Black	Black
Dashboard (upper/lower)	Black/Black	Black/Black	Black/Black
Carpet	Black	Black	Black

All pricing is RRP including VAT at 20%. Options are subject to availability and may extend time taken for delivery. Visit your local Audi Centre for a more accurate colour swatch. All colour swatches are matched as accurately as possible to the actual upholstery colours used. However, due to print processes, Audi UK cannot guarantee that the colours shown are 100% accurate.

Seat options

Further options to enhance your seats.

4-way electric lumbar support

For front seats with horizontal and vertical adjustment to further increase seat comfort.

Electrically adjustable front seats

Electric adjustment for seat height, seat forwards/backwards position, seat angle and backrest angle.

Electrically adjustable front seats with memory function for the driver's side

Electric adjustment of both front seats, with memory function for the driver's side. Includes the following: Electric adjustment for seat height, seat forwards/backwards position; seat angle and backrest angle; Electric 4-way lumbar support; Two memory spaces for the electrically adjustable driver's seat and exterior mirrors.

Heated front seats

Heating for seat and backrest centre panels. When in combination with Sport seats and leather upholstery, the side bolsters are also heated. Individually adjustable in several stages for driver and front-passenger side via the air-conditioning controls.

Heated front and outer rear seats

Works in the same way as front seat heating, enabling you to regulate the outer rear seats separately.

		SE	Sport	S line	S4
7P1	4-way electric lumbar support. Also available in Comfort and Sound Pack (WB3)	£250	£250	Standard	Standard
3L5	Electrically adjustable front seats. Also available in Comfort and Sound Pack (WB3)	£700	£700	£700	Standard
PV3	Electrically adjustable front seats with memory function for the driver's side. Only in combination with Exterior mirrors with memory function (6XF or 6XL)	£950	£950	£800	£200
	In combination with Comfort and Sound Pack (WB3)	£450	£450	£200	Not available
4A3	Heated front seats	£300	£300	£300	Standard
4A4	Heated front and outer rear seats. Not available in combination with cloth seats	£575	£575	£575	£300



Image shows A4 Sport with optional leather/Alcantara upholstery (N7U) in Rock grey (ZG)

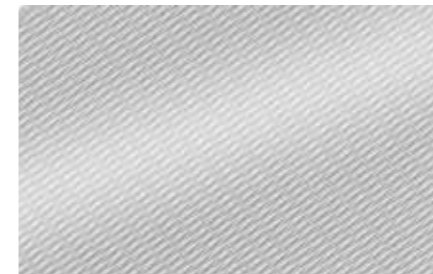

Image shows an S4 with optional Carbon Atlas inlays (5MK) and Extended LED Interior Lighting Pack (QQ2)

Inlays

Fine detailing that enhances the interior.

Inlays for instrument panel, door trims and centre console:



Aluminium Ellipse, silver

5TT	SE	Standard
	Sport	Standard
	S line	Not available
	S4	Not available



Matt brushed aluminium

5TG	SE	Not available
	Sport	Not available
	S line	Standard
	S4	Standard



Oak, natural grey

7TL	SE	£200
	Sport	£200
	S line	Not available
	S4	Not available



Walnut, dark brown

5MG	SE	£200
	Sport	£200
	S line	Not available
	S4	Not available



Piano finish, Black

5TL	SE	£200
	Sport	£200
	S line	No charge
	S4	No charge

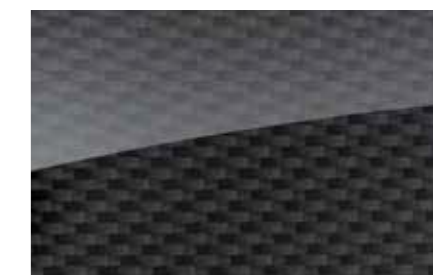

Carbon Atlas

5MK	SE	Not available
	Sport	Not available
	S line	Not available
	S4	£425

All the inlay swatches on this page are matched as accurately as possible to the actual inlay colours used. However, due to print processes, Audi UK cannot guarantee that colours shown are 100% accurate. Visit your local Audi Centre for a more accurate colour swatch. All pricing is RRP including VAT at 20%. Options are subject to availability and may extend time taken for delivery.

Interior equipment

Options to enhance the interior.

Extended LED Interior Lighting Pack – multi-coloured

In addition to the LED Interior Lighting Pack (QQ1) listed below, includes coloured ambient lighting in the following areas
 ▶ Door trims, front and rear ▶ Door storage areas, front and rear ▶ Cupholder ▶ Centre console ▶ Footwells, front and rear. Three pre-defined colour profiles are available which can be individually selected or interactively set with your Audi Drive Select mode.

LED Interior Lighting Pack

In addition to the standard interior lighting ▶ Illuminated vanity mirrors ▶ Ambient lighting in the front and rear door trims and interior door handles ▶ Courtesy lighting on the exterior door handles for easy entry and exit in the dark ▶ Entry lights, front and rear ▶ Illuminated cupholder ▶ Ambient lighting in the centre console ▶ Lighting for both front and rear footwells.

Extended Interior Upholstery Pack

Lower part of the centre console, door armrests and door pull handles in leatherette matching interior colour choice. Only available in combination with leather/Alcantara, Milano leather or Fine Nappa leather. Contrast stitching further enhances the interior elements when Fine Nappa leather is ordered.

Heated 3-spoke leather trimmed high multi-function steering wheel

Control of on-board computer, telephone, radio and navigation system (if fitted) with both hands on the steering wheel. Includes paddles for automatic transmissions. Colour to match the selected dashboard upper section. Steering wheel design is dependent on trim choice.*

Flat-bottomed 3-spoke leather trimmed high multi-function steering wheel

Control of on-board computer, telephone, radio and navigation system (if fitted) with both hands on the steering wheel. Includes paddles for automatic transmissions. Colour to match the selected dashboard upper section. When ordered on SE trim, the design of the steering wheel changes to the Sport trim design.

		SE	Sport	S line	S4
QQ2	Extended LED Interior Lighting Pack – multi-coloured. Also available in Light and Vision Pack (WB7, 9S8)	£325	£100	£100	£100
QQ1	LED Interior Lighting Pack	£225	Standard	Standard	Standard
7HB	Extended Interior Upholstery Pack	£250	£250	£250	Standard
1XP	Heated 3-spoke leather trimmed high multi-function steering wheel	£300	£300	£300	£175
2PF	Flat-bottomed 3-spoke leather trimmed high multi-function steering wheel	£225	£225	£225	£100
6NQ	Black cloth headlining	£250	£250	Standard	Standard



1. Extended LED interior lighting pack, multi-coloured (QQ2). 2. Flat-bottomed 3-spoke leather trimmed high multi-function steering wheel (2PF).

All pricing is RRP including VAT at 20%. Options are subject to availability and may extend time taken for delivery.
 *Refer to trim pages for steering wheel designs.



1.



2.

1. Rails system with load-securing kit (3GN). 2. Variable foldable trunk mat (6S).

Interior equipment

Practical options for advanced storage and stowage.

Storage Pack

Includes the following items in the car: ▶ Storage net on the back of the front seat backrests ▶ Closed storage compartment below exterior light switch on driver side ▶ Lockable glovebox ▶ Cupholder in rear centre armrest. Includes the following in the luggage compartment: ▶ Tensioning straps, left and right (Avant) ▶ Bag hook (Saloon) ▶ 12V socket ▶ Nets in the recess areas, left and right ▶ Luggage net

Rails system with load-securing kit

Flexible system for securing objects in your Avant luggage compartment. A telescopic bar and securing strap enable the luggage compartment to be divided diagonally and/or horizontally. Four sliding lashing points on the rail provide additional fastening options. After use, the kit can be stowed away in the loading floor.

Variable foldable trunk mat

Increase the everyday usability of your Avant luggage area, with a reversible, flexible rubber mat. The entire load area, even with rear seat backrest folded, can be covered to protect against dirt or damage. Or, if the trunk mat is installed horizontally, the side panel trims of the luggage compartment can be covered. Alternatively, the mat can be used flexibly to divide the luggage area into individual compartments. Thanks to its compact design, the trunk mat can be stowed away to the side of the luggage compartment.

Rear side airbags

For the outer rear seats, incorporated into the seat backrests; supplements the standard airbag systems.

Variable head restraints for front seats

With manual adjustment of headrest height, tilt and distance.

		SE	Sport	S line	S4
QE1	Storage Pack	£175	£175	£175	£175
3GN	Rails system with load-securing kit. Only available on Avant models	£200	£200	£200	£200
6S	Variable foldable trunk mat. Only available on Avant models	£125	£125	£125	Not available
4X4	Rear side airbags	£350	£350	£350	£350
3Y4	Roll-up blinds for rear door windows	£150	£150	£150	£150
5ZC	Variable head restraints for front seats	£125	£125	£125	Not available
9JD	Smoking Pack. Includes cigarette lighter and ashtrays	£50	£50	£50	£50

Technology Packs

Technology Pack ^{WB4}

This pack brings together the most popular technology options that are frequently ordered together for those wanting the highest level of connectivity and navigation.

MMI Navigation Plus with MMI Touch. In addition to standard MMI Radio Plus*, includes the following:

- ▶ 8.3" high-resolution, colour MMI display with aluminium frame
- ▶ Touch-sensitive control panel for fast, intuitive operation, handwriting recognition, and ability to move and zoom freely on the map
- ▶ Integrated navigation with 3D map display of places of interest
- ▶ Online Map updates
- ▶ Detailed route information: map preview, choice of alternative routes, POIs, lane recommendations, motorway exits, detailed junction maps and more
- ▶ Dynamic route guidance traffic updates with TMCpro (in combination with Audi Connect Infotainment Services: traffic information online)
- ▶ MMI search: free text search with intelligent suggestions provided during entry
- ▶ Natural voice recognition
- ▶ Jukebox hard drive memory for music (10 GB)
- ▶ DVD drive for music CDs and video DVDs
- ▶ 2 x SDXC memory card readers.

Driver Information System – 7" colour display
High-resolution TFT 7" full colour display in the instrument cluster offering an even better overview and readability of information compared to the standard 5" display. Displays additional information from the standard DIS such as navigation map and driver assistance systems. See page 115 for standard display information.

High multi-function 3-spoke leather trimmed steering wheel.
Includes paddles for automatic transmission. Control of onboard computer, telephone, radio and navigation system with both hands on the steering wheel. Refer to trim pages for steering wheel designs.



MMI Navigation Plus



MMI Touch



High multi-function 3-spoke leather trimmed steering wheel on S line model**



Audi Phone Box with wireless charging

Audi Connect Infotainment Services (3-year subscription).

Convenient connection of your vehicle to the internet via an integrated data module with LTE/UMTS connection. Highlights of Audi Connect Infotainment Services include navigation with Google Earth™ and Google Street View™, destination input via myAudi or Google Maps™, access to Google and Twitter, weather and news online and travel information. See pages 42-43 and 136 for more information.

Audi Phone Box with wireless charging. Offers improved reception quality and wireless charging (with Qi-enabled compatible phones). For more information, see full option description of Audi Phone Box on page 105. Audi Phone Box option also provides an additional Bluetooth interface for a second device, meaning two mobile phones can be connected to the vehicle simultaneously. For mobile phone and software version compatibility, please visit your Audi Centre or www.audi.co.uk/phonecompatibility

		SE	Sport	S line	S4
WB4	Technology Pack	£2,000	£1,450	£1,450	Not available

Technology Packs

Comfort and Sound Pack WB3

A pack that adds value by combining some of our most popular options – designed to offer convenience as well as enhancing your driving comfort, sound experience and pleasure.

Electrically adjustable front seats. Electric adjustment for seat height, seat forwards/backwards position, seat angle and backrest angle.

4-way electric lumbar support. For front seats with horizontal and vertical adjustment.

Convenience key. Access and authorisation system that works through automatic data exchange between key and vehicle, allowing the driver to keep their car key in their pocket or bag at all times. Vehicle locked and unlocked from outside via sensors on the door handles. Pressing the Start/Stop button integrated in the centre console starts and stops the engine.



Bang & Olufsen 3D Sound System

Bang & Olufsen 3D Sound System. The system features 19 loudspeakers including a subwoofer and centre loudspeaker and a 16-channel amplifier with an output of 755 watts. Spatial sound reproduction through the new 3D sound feature for the front seats. Includes speed-sensitive volume adjustment and illuminated loudspeakers within the front doors.



Electrically adjustable front seats

		SE	Sport	S line	S4
WB3	Comfort and Sound Pack	£1,775	£1,500	£1,250	Not available

Vision Pack WB6, 9S8

Keeps your focus on the road, with features that put driver's information in your line of vision as well as enhancing your headlights, in order to reduce the risk of dazzling other road users. As with other technology packs, you can expect a high level of value.



Audi Virtual Cockpit and Head-up display

Audi Virtual Cockpit. Innovative 12.3" full colour digital instrument cluster for the flexible display of information tailored to the driver's needs. Displays the following:
 ▶ Vehicle/engine speed ▶ 3D Navigation map ▶ Audi Connect Infotainment Services ▶ Radio/media information ▶ Driver assistance systems ▶ All MMI functionalities (e.g. telephone, car settings etc). The 'view' button on the multi-function steering wheel allows you to change between two differently sized representations of the instrument dials. The display with small instruments allows the onboard computer and MMI contents to be shown across the full display area.

Head-up display. Projects warning messages or driving-related information from assistance systems and navigation system (if ordered) in full colour onto the windscreen in the driver's direct field of vision, giving faster access to information. Display is adjustable in height.

High-beam assist. Within system limits, High-beam assist detects the headlights of oncoming traffic, the rear lights of other road users and light sources in built-up areas. Depending on the traffic situation, the high beam automatically adjusts to dipped beam and vice versa, improving the driver's visibility and enhancing comfort and convenience.

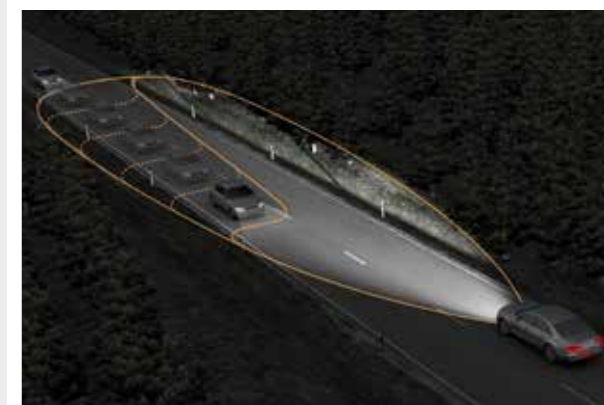

High-beam assist

		SE	Sport	S line	S4
WB6, 9S8	Vision Pack. On SE, Sport and S line only available in combination with Technology Pack (WB4)	£1,150	£1,150	£1,150	£900

Technology Packs

Light and Vision Pack WB7, 9S8

See more, both inside and outside with our advanced lighting technology and our ultimate driver's information system, Audi Virtual Cockpit. Available on S4 and S line models only, this pack combines our most innovative options with great value.

Audi Virtual Cockpit. Innovative 12.3" full colour digital instrument cluster for the flexible display of information tailored to the driver's needs. Displays the following:

- ▶ Vehicle/engine speed ▶ 3D Navigation map ▶ Audi Connect Infotainment Services ▶ Radio/media information
- ▶ Driver assistance systems ▶ All MMI functionalities (e.g. telephone, car settings etc). The 'view' button on the multi-function steering wheel allows you to change between two differently sized representations of the instrument dials. The display with small instruments allows the onboard computer and MMI contents to be shown across the full display area.



Audi Virtual Cockpit

Extended LED Interior Lighting Pack – multi-coloured.

In addition to the LED Interior Lighting Pack (QQ1) includes coloured ambient lighting in the following areas:

- ▶ Door trims, front and rear ▶ Door storage areas, front and rear ▶ Cupholder ▶ Centre console
- ▶ Footwells, front and rear. Three pre-defined colour profiles are available which can be individually selected, or interactively set with your Audi Drive Select mode.



Extended LED Interior Lighting Pack – multi-coloured



Matrix LED headlights with LED rear lights and dynamic front and rear indicators

Matrix LED headlights with LED rear lights and dynamic front and rear indicators

Audi Matrix LED technology provides precise illumination of the road whilst reducing the risk of dazzling other road users. Using information from the vehicle's sensors, camera and MMI Navigation (if equipped), Matrix LED calculates the appropriate lighting required and automatically dips

or turns off individual lighting diodes, creating corridors of lights either side of the vehicle or the object in front of it. Includes dynamic front and rear indicators which sweep from inside to out. This helps to clearly identify not only that the vehicle is turning, but in which direction.

		SE	Sport	S line	S4
WB7, 9S8	Light and Vision Pack. On S line only available in combination with Technology Pack (WB4)	Not available	Not available	£975	£750

Technology – Audio and communication

Your options for music and entertainment.

Bang & Olufsen 3D Sound System

A premium sound experience with concert hall acoustics and for the first time, with 3D stereo surround sound. The system features 19 loudspeakers, including a subwoofer and centre loudspeaker and a 16-channel amplifier with an impressive total output of 755 watts. The natural 3D surround sound is produced with additional speakers in the A-pillar, which now create a new height dimension in sound, in addition to depth and width enhancing the feeling of space. Includes speed sensitive volume adjustment and illuminated loudspeakers within the front doors.

Audi Sound System

Impressive sound with 10 loudspeakers including centre speaker and subwoofer, plus a 6-channel amplifier with a total output of 180 watts.

Audi Entertainment Mobile

Includes two detachable high definition 10.1" touch screens fitted to the back of the front seats (supplied by Audi Genuine Accessories*). The backs of the front seats are fitted with mountings and power connections. The system can be used outside the car with rechargeable battery, which is included in the package. Content is either streamed from your iOS (iPhone) or Android (Samsung, HTC, Sony etc) smartphone via an Audi App, via an integrated SD card reader, USB cable, Miracast Wi-Fi or Bluetooth. Includes two sets of headphones, USB cable and storage bag.

		SE	Sport	S line	S4
9VS	Bang & Olufsen 3D Sound System. Also available in Comfort and Sound Pack (WB3)	£975	£750	£750	£750
9VD	Audi Sound System	£275	Standard	Standard	Standard
9WQ	Audi Entertainment Mobile.* Only available in combination with Electrically adjustable front seats (3L5) and 4-way electric lumbar support (7P1)	£1,325	£1,325	£1,325	Not available



1. Bang & Olufsen 3D Sound System (9VS). 2. Audi Entertainment Mobile (9WQ).

All pricing is RRP including VAT at 20%. Options are subject to availability and may extend time taken for delivery.

*Screens must be ordered by your Audi Centre via Audi Genuine Accessories.

Technology – Audio and communication

Your options for infotainment and connectivity.

Audi Virtual Cockpit

Innovative 12.3” full colour digital instrument cluster for the flexible display of information tailored to the driver’s needs. Displays the following: ▶ Vehicle/engine speed ▶ 3D Navigation map ▶ Audi Connect Infotainment Services ▶ Radio/media information ▶ Driver assistance systems ▶ All MMI functionalities (e.g. telephone, car settings etc). The ‘view’ button on the multi-function steering wheel allows you to change between two differently sized representations of the instrument dials. The display with small instruments allows the onboard computer and MMI contents to be shown across the full display area.

MMI Navigation (SD card-based)

In addition to standard MMI Radio Plus, includes the following:

- ▶ Integrated navigation with 3D map display
- ▶ Detailed route information: map preview, choice of alternative routes, POIs, lane recommendations, motorway exits, detailed junction maps and more
- ▶ Dynamic route guidance with TMCpro (in combination with Audi Connect Infotainment Services: traffic information online)
- ▶ MMI search: free text search with intelligent suggestions provided during entry
- ▶ Natural voice recognition
- ▶ 2x SDXC memory card readers
- ▶ Audi Connect Infotainment Services (3-month trial)

For details on MMI Radio Plus please refer to the Glossary on page 116.

Audi Phone Box with wireless charging

Enables drivers to use their mobile phone in the car by placing it in the storage compartment provided in the front centre console to create a wireless connection to the vehicle aerial, improving reception quality (subject to network coverage). Operated via the MMI control panel, the multi-function steering wheel or the voice control system. Wireless charging available (with Qi-enabled compatible phones) or via USB port. Audi Phone Box option also provides an additional Bluetooth interface for a second device, meaning two mobile phones can be connected to the vehicle simultaneously. For mobile phone and software version compatibility, please visit your Audi Centre or www.audi.co.uk/phonecompatibility



1.



2.



3.

1. Audi Virtual Cockpit (9S8). 2. MMI Navigation (SD card-based) (PNU). 3. Audi Phone Box with wireless charging (9ZE).

		SE	Sport	S line	S4
9S8	Audi Virtual Cockpit. Also available in Vision Pack (WB6, 9S8) and Light and Vision Pack (WB7, 9S8). On SE, Sport and S line only available in combination with Technology Pack (WB4)	£450	£450	£450	£250
PNU	MMI Navigation (SD card-based)	£550	Standard	Standard	Not available
9ZE	Audi Phone Box with wireless charging. Also available in Technology Pack (WB4)	£325	£325	£325	£325

All pricing is RRP including VAT at 20%. Options are subject to availability and may extend time taken for delivery.

Technology – Driver assistance

Driver Assistance Pack – Tour PCN

With busier roads than ever, Audi technology can keep an extra eye out. This pack brings together the driver assistance systems that support long-distance driving, especially when driving in congestion and varying average speed limit zones. As well as helping you to drive more efficiently, the pack also includes advanced safety systems.

Adaptive Cruise Control with Stop&Go and Traffic-jam assist

Automatic distance regulation, using radar sensors to maintain the required distance between your A4 and vehicles ahead by braking and accelerating. With the Stop&Go function, the system brakes the car to a stop. The driver can select from five warning thresholds and influence the system's acceleration behaviour via Audi Drive Select. Traffic-jam assist detects vehicles ahead and on adjacent lanes to assist with the braking, acceleration and also steering up to 37mph, to keep the vehicle in lane. Adaptive Cruise Control requires additional sensors in the lower front air inlets, and results in a change to the design of the inlets and differs dependent on trim. The images below show the design for SE and Sport (left) and S line (right). Stop&Go and Traffic-jam assist are only available when ordered with S tronic or tiptronic transmissions.



Adaptive Cruise Control with Stop&Go and Traffic-jam assist*

Predictive efficiency assistant

The system uses navigation data e.g. speed limits, traffic signs, road bends, junctions and roundabouts to give the driver efficiency advice in the instrument cluster (or via the optional Audi Virtual Cockpit). In combination with Adaptive Cruise Control (ACC), the system uses the route data and speed limits to adjust the ACC desired speed and cornering accordingly. With automatic transmissions, the system activates free-wheeling mode or engine braking, which can help reduce fuel consumption and enhance ride comfort.



Predictive efficiency assistant*



Camera-based traffic sign recognition*

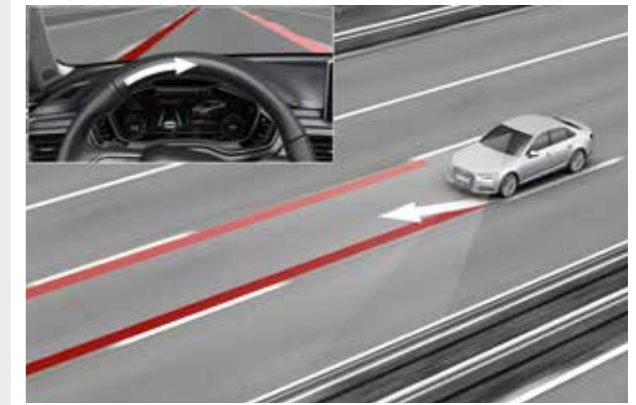

Active Lane Assist*

Pre-sense Front

Extends the collision warning and automatic braking function of Pre-sense City to cover the entire speed range and can also increase braking initiated by the driver if this is inadequate. The system uses the camera located on the front rear-view mirror to detect vehicles and pedestrians in front, in order to reduce severity of a collision, or if possible prevent an accident. The driver is first given a visual and acoustic warning followed by partial braking and then full brake application.

Collision avoidance assistant

Supports the driver's actions during an avoidance manoeuvre, reducing the likelihood of a collision or of swerving off the road. The system provides additional steering torque and uses vehicle sensors to calculate the optimum path of avoidance.

Camera-based traffic sign recognition

Speed limit and traffic sign display via the Driver's Information System (DIS) or optional Head-up display. Detects the following signs: speed limits (including temporary limits), overtaking restrictions and no-entry warnings.

Turn assist

When turning at junctions, from the moment the turn indicators are activated, the turn assist system detects approaching vehicles and applies braking to help avoid a collision.

Active Lane Assist

Detects lane boundary markings and helps the driver to stay in lane with gentle steering intervention for greater safety and convenience, particularly on motorways. Works at speeds above 37mph.

		SE	Sport	S line	S4
PCN	Driver Assistance Pack – Tour. On SE, Sport and S line only available in combination with Technology Pack (WB4), High-beam assist (8G1)	£1,250	£1,250	£1,250	£1,250

*Images show display on optional Audi Virtual Cockpit, which can be ordered as part of the Vision Pack, Light and Vision Pack or as an individual option.

Vehicle driver assistance and safety systems are not a substitute for attentive driving. Drivers retain full responsibility for providing the necessary inputs for safe control of the vehicle. System descriptions within this brochure are provided for information purposes only. System limitations and operational requirements apply. See manual for details.

All pricing is RRP including VAT at 20%. Options are subject to availability and may extend time taken for delivery.

Technology – Driver assistance

Parking Assistance Pack PCF

Enhancing the front and rear parking sensors that come as standard, this pack adds all-round cameras to help optimise your view while parking – and can even help you find and manoeuvre into a parking space.



360° camera showing bird's-eye-view

360° camera – Wide-angle lenses cover the close range around the vehicle. The driver can choose between different image representations in the MMI display, including a live “bird’s-eye-view” image for parking. Includes guidelines which help the driver manoeuvre and navigate the vehicle into the right position.

Parking assist – Searches for suitable parking spaces along the road by means of ultrasonic sensors, calculates the ideal parking path and performs the steering action virtually automatically. The system can support the driver with:

- Parallel parking in reverse
- Exiting a parallel parking space, driving forwards
- Bay parking, both reverse and forwards.

Steering is done by the vehicle, with the driver responsible for acceleration and application of the brakes.

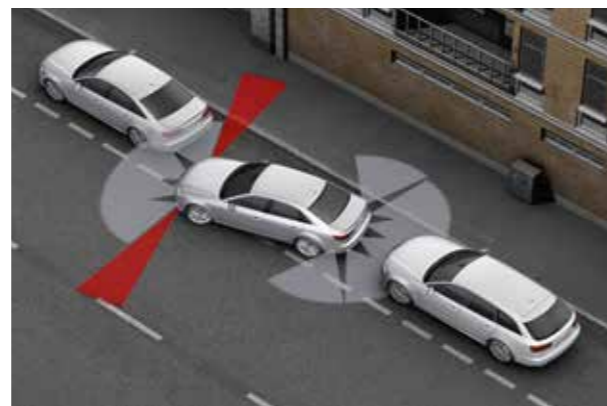

Parking assist

		SE	Sport	S line	S4
PCF	Parking Assistance Pack. Only available with optional mirrors (6XE, 6XF or 6XL) and on SE, Sport and S line models only available with Technology Pack (WB4)	£900	£900	£900	£900

Parking Assistance Pack Advanced PCZ

In addition to the contents of the Parking Assistance Pack, this pack includes the latest technology to provide help in busy traffic situations, when changing lane, exiting your car and when reversing – for the convenience and protection of all occupants.



Cross-traffic assist rear

Audi Pre-sense Basic – Audi Pre-sense is a comprehensive technical package for identifying dangers well in advance and intervening appropriately to provide extra safety and protection. Where necessary, actions are taken to protect the driver and passengers from a potential collision. These include: front seat belt tightening, activating the hazard warning system, closing the windows and the sunroof (if fitted).

Audi Pre-sense Rear – Monitors vehicles following from behind and if a potential collision is detected, the driver is first warned visually via flashing light, then Audi Pre-sense Basic measures (e.g. closing windows) are initiated and if a collision is unavoidable, the system will tighten the front seat belts. The system is deactivated when towing.

Audi Side Assist – Aids the driver when changing lane. Audi Side Assist monitors the area behind the vehicle, using radar sensors located discreetly in the rear bumper, informing the driver with a visual warning signal in the door mirror if there is a vehicle in their blind spot or approaching quickly from behind.

Cross-traffic assist rear – Warns the driver of traffic crossing behind their own vehicle when reversing. The system alerts the driver first visually and then acoustically via the MMI, and then applies a brake jolt if a potential collision is detected.

Exit Warning – Monitors the rear and side of your stationary A4 and warns the occupants via a warning light on the door before they exit that vehicles/cyclists are approaching from behind.



Exit warning

		SE	Sport	S line	S4
PCZ	Parking Assistance Pack Advanced. Only available with optional mirrors (6XE, 6XF or 6XL) and on SE, Sport and S line models only available with Technology Pack (WB4)	£1,350	£1,350	£1,350	£1,350

Vehicle driver assistance and safety systems are not a substitute for attentive driving. Drivers retain full responsibility for providing the necessary inputs for safe control of the vehicle. System descriptions within this brochure are provided for information purposes only. System limitations and operational requirements apply. See manual for details.

Technology – Driver assistance

Advanced options to help you on and off the road.

Head-up display

Projects warning messages or driving-related information from assistance systems and the navigation system (if ordered) in full colour onto the windscreen in the driver's direct field of vision, giving the driver faster access to information. Display is adjustable in height.

Camera-based traffic sign recognition

Speed limit and traffic sign display via the Driver's Information System (DIS) or optional Head-up display. Detects the following signs: speed limits (including temporary limits), overtaking restrictions and no-entry warnings.

Rear-view camera

An image of the area behind the vehicle is shown on the MMI display. Reversing camera is concealed in the handle strip of the luggage compartment lid.

Advanced key with electric hands-free boot opening system

Access and authorisation system that works through automatic data exchange between key and vehicle, allowing the driver to keep their car key in their pocket or bag at all times. To unlock and open, simply lift the exterior door handle. Pressing the Start/Stop button integrated in the centre console starts and stops the engine. Also includes an electric hands-free boot lid release sensor located underneath the rear bumper, which can be operated by a simple kicking movement underneath the sensor. Opening is also possible with the vehicle locked.

Garage door opener (Homelink®)*

Programmable radio-operated remote control buttons incorporated in the interior lighting module. Can be used for opening and/or closing garage doors and exterior gates. Control of security and lighting systems is also possible.**

		SE	Sport	S line	S4
KS1	Head-up display. Also available in Vision Pack (WBG, 9S8)	£900	£900	£900	£900
QR9	Camera-based traffic sign recognition. On SE, Sport and S line models only in combination with Technology Pack (WB4)	£275	£275	£275	£275
KA2	Rear-view camera	£450	£450	£450	£450
PGD/PGB	Advanced key with electric hands-free boot opening system. Saloon (PGD), Avant (PGB)	£525	£525	£525	£525
UH2	Hill-hold assist	£75	£75	£75	£75
VC1	Garage door opener (Homelink®)*	£250	£250	£250	£250



1. Head-up display (KS1). 2. Rear-view camera (KA2). 3. Camera-based traffic sign recognition (QR9). 4. Advanced key, with electric hands-free boot opening system (PGD or PGB).

All pricing is RRP including VAT at 20%. Options are subject to availability and may extend time taken for delivery.
*Homelink® is a registered trademark of Johnson Controls. **For information on compatible hand transmitters, please go to www.eurohomelink.com

Vehicle driver assistance and safety systems are not a substitute for attentive driving. Drivers retain full responsibility for providing the necessary inputs for safe control of the vehicle. System descriptions within this brochure are provided for information purposes only. System limitations and operational requirements apply. See manual for details.

Audi Genuine Accessories

Personalise your Audi today.

Make your Audi A4 your own by adding some genuine accessories. All created by Audi and specially crafted for our models, so they'll deliver the high standards you expect. What you see here is just a selection. See the full collection at www.audi.co.uk/accessories or speak to your Audi Centre for pricing.



Rubber/Textile floor mats
Protect the A4 interior from muddy feet and daily wear and tear.



Boot liner
Avoid damage while loading and unloading luggage.



Roof bars
Transport larger items, from bikes to snowboards.



Roof box
Add to the A4's already generous luggage capacity.



Audi entertainment mobile
Keep rear seat passengers entertained with the double screen package.



Laptop bag
Keep everything organised while you travel.

Audi warranty

Protection against the unexpected.

All new Audi models come with a 3-year warranty as standard, and you can choose to extend this to a 4 or 5-year warranty* for a one-off cost. What's more, if you decide to sell your Audi before the warranty expires, it will be fully transferred to the new owner. Warranty terms and conditions apply. Please see www.audi.co.uk/warrantyterms for further details.

		SE	Sport	S line	S4
-	Audi warranty , covering you for unlimited-mileage in the first two years of ownership, and up to 60,000 miles in the third year. Transferable between owners**	Standard	Standard	Standard	Standard
EA6	Audi warranty , covering you for up to four years or 75,000 miles, whichever comes sooner. Cover includes a 2-year unlimited-mileage warranty, and up to 75,000 miles in the third and fourth years. Transferable between owners**	£385	£385	£385	£385
EA9	Audi warranty , covering you for up to five years or 90,000 miles, whichever comes sooner. Cover includes a 2-year unlimited-mileage warranty, and up to 90,000 miles in the third, fourth and fifth years. Transferable between owners**	£905	£905	£905	£905

*3-year warranty consists of a 2-year unlimited-mileage warranty and a third year warranty with a 60,000-mile limitation.
4-year warranty consists of a 2-year unlimited-mileage warranty and two further years' coverage with a 75,000-mile limitation.
5-year warranty consists of a 2-year unlimited-mileage warranty and three further years' coverage with a 90,000-mile limitation.
**Only available before registration of your Audi A4. Please speak to your Audi Centre for full details.

Audi glossary

Your guide to A4 and S4 standard equipment.

AdBlue®

All Audi A4 TDI models are fitted with AdBlue® technology. The AdBlue® solution is stored in a tank positioned near the car's conventional fuel tank, accessed through a screw-cap usually found next to the car's fuel filler nozzle. The AdBlue® tank may require a top-up between services. For information on the size of the AdBlue® tank on your TDI model, please see pages 118-119, 122-123 and 126.

Audi Connect Infotainment Services, 3-month trial

Free use of Audi Connect Infotainment Services for a period of three months. See page 42-43 and 136 for more information on Audi Connect services. Only available with MMI Navigation.

Audi Drive Select

Changes your car's handling and response at the touch of a button to suit the way you want to drive. Enables the driver to alter the throttle response, gear-shift characteristics and steering feel between four pre-set modes: Comfort, Auto, Dynamic and Efficiency. If your vehicle is equipped with MMI Navigation (standard on Sport, S line and S4 models) an additional 'Individual' mode is available.

The Efficiency mode sets the engine, automatic transmission, air conditioning and cruise control systems to a more fuel efficient basic setting. Efficiency mode is not available on 1.4 TFSI engines.

Automatic Start-Stop with coasting functionality

Helps to reduce fuel consumption by switching off the engine when the vehicle is stationary, and also when slowing down e.g. on approach to traffic lights. The engine restarts as soon as the clutch is depressed or the foot brake is released. It can be deactivated via a button at any time.

Bluetooth interface (one device)

This allows Bluetooth-compatible mobile phones to be connected to the vehicle, allowing hands-free calls via the microphone. Also includes Bluetooth audio streaming (dependent on mobile phone capability). For mobile phone and software versions compatibility, please visit your Audi Centre or www.audi.co.uk/phonecompatibility

Comfort Dynamic suspension

Outstanding handling characteristics and excellent driving comfort with lightweight five-link front and rear suspension and tubular anti-roll bar.

Cruise control system with speed limiter

At speeds above approximately 19mph, cruise control maintains the set desired speed. The speed limiter allows a maximum speed to be set which can not be exceeded even by increasing the pressure on the accelerator pedal helping the driver to keep to the speed limit. The driver can temporarily disable or deactivate the speed limiter at any time by kick down (pressing on the accelerator pedal past the point of resistance). Also includes free-wheeling capability, which helps to reduce fuel consumption through intelligent use of free-wheeling phases when cruise control is active. This is available in the Audi Drive Select Efficiency mode and only in combination with automatic transmissions.

Deluxe 3-zone electronic climate control

Design-led and intuitive operation via a large TFT display which features touch sensitive rocker switches and integrated digital temperature displays in the rotary push buttons. Electronically regulates air temperature, air flow rate and air distribution. Exact temperature can be set individually for driver, front passenger and rear seats. The rear air conditioning can be operated from the front and additional control panel in the rear. Eco button activates efficiency-optimised air conditioning. The newly developed air conditioning blower is more efficient, quieter and lighter. The system automatically selects the climate control mode for optimum comfort and maximum efficiency. Air quality inside the vehicle is also improved thanks to the combination filter with activated charcoal, air quality sensor and automatic air recirculation control.

Driver's Information System – 5" monochrome display

Standard on all models with MMI Radio Plus and MMI Navigation. 5" TFT monochrome display in the instrument cluster. Displays the following: ▶ Time ▶ Distance travelled ▶ Outside temperature ▶ Fuel level warning with remaining range ▶ Gear change recommendation (for manual transmission and automatic transmission in manual mode) ▶ Telephone menu ▶ Current radio station or music title, radio and media lists.

The on-board computer with short-term and long-term memory supplies information about the average and momentary fuel consumption, remaining range, average speed, driving time and distance travelled.

Efficiency programme

Supports the driver with overviews of fuel consumption data, gear-change indicator (for manual transmission) and tips for more economical driving. Displayed in the Driver's Information System. Includes attention assist.

Electric boot lid release – Saloon models only

The luggage compartment lid opens automatically when the luggage compartment is unlocked with the remote control key, the button in the driver's door or by pushing the soft-touch release on the lid.

Electric load area cover – Avant models only

Electric, rail-mounted cover for the luggage compartment. Moves up automatically, uncovering the load area as soon as the tailgate is opened (with both manual and electric opening). When the tailgate is closed, the load area cover moves down again to cover the load area. The load area cover can still be retracted manually.

Electromechanical parking brake

Includes parking brake function when stationary, drive-off assistance function through automatic release when driving away and emergency braking function whilst driving, acting on all four wheels.

Audi glossary

Exhaust system

Four different tailpipe versions differentiate models visually according to their engine for both Saloon and Avant.

Single-branch design with one tailpipe on the left:

1.4 TFSI and 2.0 TDI 150PS

Single-branch design with two tailpipes on the left:

2.0 TDI 190PS and 3.0 TDI

Dual-branch design with one tailpipe each on the

left and right: 2.0 TFSI

‘S’ specific dual-branch tailpipes, with twin oval pipes

each on left and right: 3.0 TFSI

Chrome-plated exhaust trims are standard on every A4

Interior lighting

Includes the following:

- ▶ Passive door warning lights
- ▶ Front and rear roof module lights
- ▶ Glove compartment light (with bulb)
- ▶ Tailgate lighting (Avant only)
- ▶ Luggage compartment lighting

Keyless go

Conveniently allows the engine to be started by simply pressing the Start/Stop button in the centre console allowing the driver to keep the key in their pocket or bag.

MMI Radio Plus with Smartphone Interface and MMI controller

Includes the following:

- ▶ 7” colour MMI display with black frame
- ▶ MMI controller with integrated joystick function
- ▶ Audi Smartphone Interface – Connects your smartphone with your A4 bringing your mobile content seamlessly via USB directly into the MMI display. Navigation, telephone, music and selected third-party apps can be easily controlled via the MMI controller and via voice control system. See pages 40-41 for more information
- ▶ Voice recognition and control – a short press on the voice control button activates Audi voice control and a long press activates your smartphone voice assistant
- ▶ Two USB charging ports and one AUX-IN located in the centre console
- ▶ CD drive
- ▶ 2x SDXC card readers
- ▶ AM/FM/DAB radio
- ▶ 8 passive loudspeakers (four front and four rear)
- ▶ Ready for Nav – preparation that enables MMI Radio Plus to be upgraded to MMI Navigation as a retro-fit at your local Audi Centre

Multi-collision brake assist

Once a primary collision has happened, Multi-collision brake assist supports to avoid additional accidents if possible. The system automatically initiates a full braking application to reduce the risk of skidding and further collisions in an accident. The reduction in speed also makes the vehicle easier to control after impact.

Pop-up bonnet

Active hinges raise the bonnet if pedestrian contact is sensed.

Power operated tailgate – Avant models only

The luggage compartment lid opens automatically when the luggage compartment is unlocked with the remote control key, the button in the driver’s door or by pushing the soft-touch release on the lid. In combination with optional convenience key or Advanced key, opening/closing is also possible from the key.

Pre-sense City

The system uses the camera located on the front rear-view mirror to detect vehicles and pedestrians in front. If an imminent collision is detected, the system warns the driver. Subject to certain system limits, up to speeds of approximately 52mph, the system may initiate emergency braking application and if possible prevent the collision.

Vehicle driver assistance and safety systems are not a substitute for attentive driving. Drivers retain full responsibility for providing the necessary inputs for safe control of the vehicle. System descriptions within this brochure are provided for information purposes only. System limitations and operational requirements apply. See manual for details.

Parking System Plus

Acoustic and visual park assist system for the front and rear with MMI screen display showing a graphic representation of the distance to any obstacles detected outside and within the driving path. Measurement is by ultrasonic sensors concealed in the bumpers.

‘S’ Sport suspension

For S4 Saloon/S4 Avant models only, this new suspension offers stiffer springs and damping for more direct contact with the road for even more sportier handling and at the same time increased comfort. Lowered by 20mm compared to comfort dynamic suspension.

S tronic 7-speed transmission

The new S tronic transmission with completely revised driveline has remarkable gear-shift performance, sporty set-up. Now available for the first time with front-wheel drive. S tronic can be manually operated using the shift paddles behind the steering wheel or via the selector lever. In automatic mode, programmes D (Drive) and S (Sport) can be selected.

Tiptronic 8-speed transmission

For engines with torque higher than 400 Nm, Tiptronic enhances the quattro experience with improved traction and driving dynamics. The gear-shifts between the eight speeds are achieved smoothly, quickly and are always appropriate for the current driving situation.

Tow bar preparation

Includes wiring. The set of parts for retrofitting are available from Audi Genuine Accessories or as an option (1D4). Please contact an Audi Centre for more details.

Tyre-pressure warning light

Visual and acoustic warning if the pressure drops in one or more tyre.

Xenon headlights with LED daytime-running lights

The Xenon high-beam headlights underline the progressive character of the Audi A4.

All-weather headlights with dynamic headlight adjustment. Dipped beam and high beam, featuring Xenon technology with LED daytime-running lights.

A4 Saloon technical data

Key information about your car.

All of our A4 engines meet EU6 emissions standards. For diesel engines, this means the addition of an AdBlue® tank to ensure compliance. The AdBlue® tank size for your engine is shown below and it may require a top-up between services.

	Petrol				Diesel		
Engine	1.4 TFSI	2.0 TFSI	2.0 TFSI	2.0 TFSI quattro	2.0 TDI ultra*	2.0 TDI ultra*	2.0 TDI
Transmission	6-speed manual	6-speed manual	7-speed S tronic	7-speed S tronic	6-speed manual	7-speed S tronic	6-speed manual
Cylinder	4-cylinder	4-cylinder	4-cylinder	4-cylinder	4-cylinder	4-cylinder	4-cylinder
Displacement, cubic cm (valves per cylinder)	1395	1984	1984	1984	1968	1968	1968
Max. power, ¹ PS at rpm	150/5000-6000	190/4200-6000	190/4200-6000	252/5000-6000	150/3250-4200	150/3250-4200	150/3250-4200
Performance							
Max. torque, Nm at rpm	250/1500-3500	320/1450-4200	320/1450-4200	370/1600-4500	320/1500-3250	320/1500-3250	320/1500-3250
0-62mph acceleration, seconds	8.7	7.2	7.3	5.8	8.9	8.7	8.9
Top speed, mph	130	149	149	155	130	130	137
Weight							
Unladen weight, ² kg	1320	1380	1405	1510	1430	1470	1430
Gross weight limit, kg	1890	1960	1985	2080	2030	2070	2030
Further information							
Roof load limit/nose weight	90/80	90/80	90/80	90/80	90/80	90/80	90/80
Max trailer load unbraked ³	690	720	740	750	750	750	750
Max trailer load with 12%/8% gradient ³	1400/1600	1500/1700	1500/1700	1700/1900	1400/1600	1400/1600	1700/1900
Fuel tank approx capacity, litres	54	54	54	58	40	40	40
AdBlue® tank approx capacity, litres	n/a	n/a	n/a	n/a	12	12	12
ABI insurance group 1-50 ⁴	20E	26E	26E	30E	20E	20E	20E

*ultra TDI models come with low rolling resistance tyres.

¹The given value was obtained in accordance with the specified measurement procedure (the respective current version of the Directive 80/1269/EEC). The maximum power output figures are quoted in PS (or Pferdestärke, which is the metric equivalent of brake horsepower). To convert to brake horsepower, divide the PS figure by 1.0139.

Diesel								
2.0 TDI	2.0 TDI ultra*	2.0 TDI ultra*	2.0 TDI	2.0 TDI	2.0 TDI quattro	3.0 V6 TDI	3.0 V6 TDI quattro	3.0 V6 TDI quattro
7-speed S tronic	6-speed manual	7-speed S tronic	6-speed manual	7-speed S tronic	7-speed S tronic	7-speed S tronic	7-speed S tronic	8-speed tiptronic
4-cylinder	4-cylinder	4-cylinder	4-cylinder	4-cylinder	4-cylinder	6-cylinder	6-cylinder	6-cylinder
1968	1968	1968	1968	1968	1968	2967	2967	2967
150/3250-4200	190/3800-4200	190/3800-4200	190/3800-4200	190/3800-4200	190/3800-4200	218/4000-5000	218/4000-5000	272/3250-4250
320/1500-3250	400/1750-3000	400/1750-3000	400/1750-3000	400/1750-3000	400/1750-3000	400/1250-3750	400/1250-3750	600/1500-3000
8.7	7.7	7.7	7.7	7.7	7.2	6.6	6.3	5.3
136	130	130	149	147	146	155	155	155
1465	1430	1470	1450	1480	1575	1540	1620	1660
2065	2040	2070	2045	2075	2160	2110	2190	2230
90/80	90/80	90/80	90/80	90/80	90/80	90/80	90/80	90/80
750	750	750	750	750	750	750	750	750
1700/1900	1400/1600	1400/1600	1700/1900	1700/1900	1800/2000	1700/1900	1800/2000	1900/2100
40	40	40	40	40	58	54	58	58
12	12	12	12	12	12	12	12	12
20E	24E	27E	26E	26E	26E	27E	27E	36E

²Vehicle's unladen weight without driver (calculated in accordance with the current version of Directive (80/1268/EEC). The fitting of additional equipment may increase the vehicle's unladen weight and drag coefficient, whereupon the potential carrying capacity and top speed will be correspondingly reduced.

³The engine's power output always goes down with increasing altitude. At 1,000m above sea level, and for every additional 1,000m, deduct 10% from the weight of the outfit (trailer load limit + gross weight of the towing vehicle). ⁴Highest insurance group rating shown. Group may be lower dependent on trim level. Please visit www.thatcham.org/abigrouprating for details.

A4 Saloon technical data

Depending on your chosen A4 wheel size, different efficiency figures for CO₂ emissions and fuel consumption will apply (based on EU directive no. 715/2007 effective 01/09/14). This table is a quick reference guide to help you find the correct values based on wheel sizes and your chosen engine.

		Petrol				Diesel		
Engine		1.4 TFSI	2.0 TFSI	2.0 TFSI	2.0 TFSI quattro	2.0 TDI ultra*	2.0 TDI ultra*	2.0 TDI
Transmission		6-speed manual	6-speed manual	7-speed S tronic	7-speed S tronic	6-speed manual	7-speed S tronic	6-speed manual
Max. power; ¹ PS at rpm		150/5000-6000	190/4200-6000	190/4200-6000	252/5000-6000	150/3250-4200	150/3250-4200	150/3250-4200
Wheel and Tyre Clustering								
CO ₂ emissions, ² g/km	17" wheels	126	127	116	136	99	101	n/a
	18" wheels	128	130	119	141	103	107	106
	19" wheels	n/a	134	122	144	n/a	n/a	111
Benefit in kind 2016/17 tax year (BIK)%	17" wheels	22%	22%	20%	24%	19%	20%	n/a
	18" wheels	22%	23%	20%	25%	20%	21%	21%
	19" wheels	n/a	23%	21%	25%	n/a	n/a	22%
Fuel consumption, ² mpg (l/100km) Urban	17" wheels	41.5 (6.8)	39.2 (7.2)	44.1 (6.4)	36.7 (7.7)	62.8 (4.5)	60.1 (4.7)	n/a
	18" wheels	40.9 (6.9)	38.7 (7.3)	42.8 (6.6)	36.2 (7.8)	60.1 (4.7)	57.6 (4.9)	58.9 (4.8)
	19" wheels	n/a	38.2 (7.4)	42.8 (6.6)	35.8 (7.9)	n/a	n/a	56.5 (5.0)
Fuel consumption, ² mpg (l/100km) Extra Urban	17" wheels	62.8 (4.5)	61.4 (4.6)	65.7 (4.3)	56.5 (5.0)	83.1 (3.4)	80.7 (3.5)	n/a
	18" wheels	61.4 (4.6)	58.9 (4.8)	62.8 (4.5)	54.3 (5.2)	78.5 (3.6)	76.3 (3.7)	76.3 (3.7)
	19" wheels	n/a	56.5 (5.0)	60.1 (4.7)	52.3 (5.4)	n/a	n/a	72.4 (3.9)
Fuel consumption, ² mpg (l/100km) Combined	17" wheels	53.3 (5.3)	50.4 (5.6)	55.4 (5.1)	47.9 (5.9)	74.3 (3.8)	72.4 (3.9)	n/a
	18" wheels	52.3 (5.4)	49.6 (5.7)	53.3 (5.3)	45.6 (6.2)	70.6 (4.0)	68.9 (4.1)	70.6 (4.0)
	19" wheels	n/a	47.9 (5.9)	52.3 (5.4)	44.8 (6.3)	n/a	n/a	67.3 (4.2)

*All TDI ultra engines come with rolling resistance tyres.

¹The given value was obtained in accordance with the specified measurement procedure (the respective current version of the Directive 80/1269/EEC). The maximum power output figures are quoted in PS (or Pferdestärke, which is the metric equivalent of brake horsepower). To convert to brake horsepower, divide the PS figure by 1.0139.

Diesel								
2.0 TDI	2.0 TDI ultra*	2.0 TDI ultra*	2.0 TDI	2.0 TDI	2.0 TDI quattro	3.0 V6 TDI	3.0 V6 TDI quattro	3.0 V6 TDI quattro
7-speed S tronic	6-speed manual	7-speed S tronic	6-speed manual	7-speed S tronic	7-speed S tronic	7-speed S tronic	7-speed S tronic	8-speed tiptronic
150/3250-4200	190/3800-4200	190/3800-4200	190/3800-4200	190/3800-4200	190/3800-4200	218/4000-5000	218/4000-5000	272/3250-4250
n/a	102	103	n/a	n/a	114	109	119	n/a
109	107	109	113	111	118	114	123	134
112	n/a	n/a	118	113	121	117	127	137
n/a	20%	20%	n/a	n/a	22%	21%	23%	n/a
21%	21%	21%	22%	22%	23%	22%	24%	26%
22%	n/a	n/a	23%	22%	24%	23%	25%	27%
n/a	58.9 (4.8)	60.1 (4.7)	n/a	n/a	55.4 (5.1)	58.9 (4.8)	57.6 (4.9)	n/a
56.5 (5.0)	56.5 (5.0)	57.6 (4.9)	54.3 (5.2)	57.6 (4.9)	54.3 (5.2)	58.9 (4.8)	56.5 (5.0)	51.4 (5.5)
55.4 (5.1)	n/a	n/a	52.3 (5.4)	56.5 (5.0)	53.3 (5.3)	57.6 (4.9)	55.4 (5.1)	50.4 (5.6)
n/a	80.7 (3.5)	80.7 (3.5)	n/a	n/a	70.6 (4.0)	70.6 (4.0)	64.2 (4.4)	n/a
74.3 (3.8)	76.3 (3.7)	74.3 (3.8)	72.4 (3.9)	74.3 (3.8)	68.9 (4.1)	68.9 (4.1)	61.4 (4.6)	58.9 (4.8)
72.4 (3.9)	n/a	n/a	68.9 (4.1)	72.4 (3.9)	65.7 (4.3)	65.7 (4.3)	60.1 (4.7)	57.6 (4.9)
n/a	72.4 (3.9)	70.6 (4.0)	n/a	n/a	64.2 (4.4)	67.3 (4.2)	61.4 (4.6)	n/a
67.3 (4.2)	68.9 (4.1)	67.3 (4.2)	64.2 (4.4)	67.3 (4.2)	62.8 (4.5)	64.2 (4.4)	60.1 (4.7)	55.4 (5.1)
65.7 (4.3)	n/a	n/a	62.8 (4.5)	65.7 (4.3)	61.4 (4.6)	62.8 (4.5)	58.9 (4.8)	54.3 (5.2)

²Fuel consumption and CO₂ emissions figures are obtained under standardised test conditions (Directive 93/116/EEC) using a representative model. This allows direct comparison between different models from different manufacturers, but may not represent the actual fuel consumption achieved in 'real world' driving conditions and may be affected by optional equipment. More information is available at www.dft.gov.uk/vca

A4 Avant technical data

Key information about your car.

All of our A4 engines meet EU6 emissions standards. For diesel engines, this means the addition of an AdBlue® tank to ensure compliance. The AdBlue® tank size for your engine is shown below and it may require a top-up between services.

	Petrol				Diesel		
Engine	1.4 TFSI	2.0 TFSI	2.0 TFSI	2.0 TFSI quattro	2.0 TDI ultra*	2.0 TDI ultra*	2.0 TDI
Transmission	6-speed manual	6-speed manual	7-speed S tronic	7-speed S tronic	6-speed manual	7-speed S tronic	6-speed manual
Cylinder	4-cylinder	4-cylinder	4-cylinder	4-cylinder	4-cylinder	4-cylinder	4-cylinder
Displacement, cubic cm (valves per cylinder)	1395	1984	1984	1984	1968	1968	1968
Max. power, ¹ PS at rpm	150/5000-6000	190/4200-6000	190/4200-6000	252/5000-6000	150/3250-4200	150/3250-4200	150/3250-4200
Performance							
Max. torque, Nm at rpm	250/1500-3500	320/1450-4200	320/1450-4200	370/1600-4500	320/1500-3250	320/1500-3250	320/1500-3250
0-62mph acceleration, seconds	9.0	7.5	7.5	6.0	9.2	9.0	9.2
Top speed, mph	130	146	148	155	130	130	133
Weight							
Unladen weight, ² kg	1370	1435	1460	1540	1480	1525	1475
Gross weight limit, kg	1960	2030	2060	2130	2100	2145	2095
Further information							
Roof load limit/nose weight	90/80	90/80	90/80	90/80	90/80	90/80	90/80
Max trailer load unbraked ³	720	750	750	750	750	750	750
Max trailer load with 12%/8% gradient ³	1400/1600	1500/1700	1500/1700	1700/1900	1400/1600	1400/1600	1700/1900
Fuel tank approx capacity, litres	54	54	54	58	40	40	40
AdBlue® tank approx capacity, litres	n/a	n/a	n/a	n/a	12	12	12
ABI insurance group 1-50 ⁴	TBC	26E	26E	30E	20E	20E	20E

*ultra TDI models come with low rolling resistance tyres.

¹The given value was obtained in accordance with the specified measurement procedure (the respective current version of the Directive 80/1269/EEC). The maximum power output figures are quoted in PS (or Pferdestärke, which is the metric equivalent of brake horsepower). To convert to brake horsepower, divide the PS figure by 1.0139.

Diesel								
2.0 TDI	2.0 TDI ultra*	2.0 TDI ultra*	2.0 TDI	2.0 TDI	2.0 TDI quattro	3.0 V6 TDI	3.0 V6 TDI quattro	3.0 V6 TDI quattro
7-speed S tronic	6-speed manual	7-speed S tronic	6-speed manual	7-speed S tronic	7-speed S tronic	7-speed S tronic	7-speed S tronic	8-speed tiptronic
4-cylinder	4-cylinder	4-cylinder	4-cylinder	4-cylinder	4-cylinder	6-cylinder	6-cylinder	6-cylinder
1968	1968	1968	1968	1968	1968	2967	2967	2967
150/3250-4200	190/3800-4200	190/3800-4200	190/3800-4200	190/3800-4200	190/3800-4200	218/4000-5000	218/4000-5000	272/3250-4250
320/1500-3250	400/1750-3000	400/1750-3000	400/1750-3000	400/1750-3000	400/1750-3000	400/1250-3750	400/1250-3750	600/1500-3000
9.0	7.9	7.9	7.9	7.9	7.4	6.7	6.4	5.4
132	130	130	146	143	143	152	152	155
1525	1575	1530	1515	1530	1615	1595	1660	1695
2145	2120	2150	2130	2145	2220	2185	2250	2285
90/80	90/80	90/80	90/80	90/80	90/80	90/80	90/80	90/80
750	750	750	750	750	750	750	750	750
1700/1900	1400/1600	1400/1600	1700/1900	1700/1900	1800/2000	1700/1900	1800/2000	1900/2100
40	40	40	40	40	58	54	58	58
12	12	12	12	12	12	12	12	12
20E	24E	24E	26E	26E	26E	27E	27E	36E

²Vehicle's unladen weight without driver (calculated in accordance with the current version of Directive (80/1268/EEC). The fitting of additional equipment may increase the vehicle's unladen weight and drag coefficient, whereupon the potential carrying capacity and top speed will be correspondingly reduced.

³The engine's power output always goes down with increasing altitude. At 1,000m above sea level, and for every additional 1,000m, deduct 10% from the weight of the outfit (trailer load limit + gross weight of the towing vehicle). ⁴Highest insurance group rating shown. Group may be lower dependent on trim level. Please visit www.thatcham.org/abigrouprating for details.

A4 Avant technical data

Depending on your chosen A4 wheel size, different efficiency figures for CO₂ emissions and fuel consumption will apply (based on EU directive no. 715/2007 effective 01/09/14). This table is a quick reference guide to help you find the correct values based on wheel sizes and your chosen engine.

		Petrol				Diesel		
Engine		1.4 TFSI	2.0 TFSI	2.0 TFSI	2.0 TFSI quattro	2.0 TDI ultra*	2.0 TDI ultra*	2.0 TDI
Transmission		6-speed manual	6-speed manual	7-speed S tronic	7-speed S tronic	6-speed manual	7-speed S tronic	6-speed manual
Max. power, ¹ PS at rpm		150/5000-6000	190/4200-6000	190/4200-6000	252/5000-6000	150/3250-4200	150/3250-4200	150/3250-4200
Wheel and Tyre Clustering								
CO ₂ emissions, ² g/km	17" wheels	131	132	121	139	104	104	n/a
	18" wheels	133	135	124	144	108	110	111
	19" wheels	n/a	139	128	147	n/a	n/a	116
Benefit in kind 2016/17 tax year (BIK)%	17" wheels	23%	23%	21%	24%	20%	20%	n/a
	18" wheels	23%	24%	21%	25%	21%	22%	22%
	19" wheels	n/a	24%	22%	26%	n/a	n/a	23%
Fuel consumption, ² mpg (l/100km) Urban	17" wheels	40.4 (7.0)	38.2 (7.4)	42.8 (6.6)	36.7 (7.7)	60.1 (4.7)	58.9 (4.8)	n/a
	18" wheels	39.8 (7.1)	37.7 (7.5)	42.2 (6.7)	36.2 (7.8)	58.9 (4.8)	56.5 (5.0)	56.5 (5.0)
	19" wheels	n/a	36.7 (7.7)	41.5 (6.8)	35.8 (7.9)	n/a	n/a	55.4 (5.1)
Fuel consumption, ² mpg (l/100km) Extra Urban	17" wheels	58.9 (4.8)	58.9 (4.8)	62.8 (4.5)	55.4 (5.1)	78.5 (3.6)	78.5 (3.6)	n/a
	18" wheels	58.9 (4.8)	56.5 (5.0)	58.9 (4.8)	52.3 (5.4)	76.3 (3.7)	74.3 (3.8)	74.3 (3.8)
	19" wheels	n/a	54.3 (5.2)	57.6 (4.9)	51.4 (5.5)	n/a	n/a	70.6 (4.0)
Fuel consumption, ² mpg (l/100km) Combined	17" wheels	51.4 (5.5)	48.7 (5.8)	53.3 (5.3)	46.3 (6.1)	70.6 (4.0)	70.6 (4.0)	n/a
	18" wheels	50.4 (5.6)	47.9 (5.9)	52.3 (5.4)	44.8 (6.3)	68.9 (4.1)	67.3 (4.2)	67.3 (4.2)
	19" wheels	n/a	46.3 (6.1)	50.4 (5.6)	44.1 (6.4)	n/a	n/a	65.7 (4.3)

*All TDI ultra engines come with rolling resistance tyres.

¹The given value was obtained in accordance with the specified measurement procedure (the respective current version of the Directive 80/1269/EEC). The maximum power output figures are quoted in PS (or Pferdestärke, which is the metric equivalent of brake horsepower). To convert to brake horsepower, divide the PS figure by 1.0139.

Diesel								
2.0 TDI	2.0 TDI ultra*	2.0 TDI ultra*	2.0 TDI	2.0 TDI	2.0 TDI quattro	3.0 V6 TDI	3.0 V6 TDI quattro	3.0 V6 TDI quattro
7-speed S tronic	6-speed manual	7-speed S tronic	6-speed manual	7-speed S tronic	7-speed S tronic	7-speed S tronic	7-speed S tronic	8-speed tiptronic
150/3250-4200	190/3800-4200	190/3800-4200	190/3800-4200	190/3800-4200	190/3800-4200	218/4000-5000	218/4000-5000	272/3250-4250
n/a	106	106	n/a	n/a	116	114	123	n/a
112	111	112	116	113	120	117	126	139
115	n/a	n/a	121	116	123	121	129	142
n/a	21%	21%	n/a	n/a	23%	22%	24%	n/a
22%	22%	22%	23%	22%	24%	23%	25%	27%
23%	n/a	n/a	24%	23%	24%	24%	25%	28%
n/a	56.5 (5.0)	58.9 (4.8)	n/a	n/a	54.3 (5.2)	57.6 (4.9)	56.5 (5.0)	n/a
55.4 (5.1)	55.4 (5.1)	56.5 (5.0)	54.3 (5.2)	57.6 (4.9)	53.3 (5.3)	57.6 (4.9)	55.4 (5.1)	49.6 (5.7)
54.3 (5.2)	n/a	n/a	52.3 (5.4)	56.5 (5.0)	52.3 (5.4)	56.5 (5.0)	54.3 (5.2)	48.7 (5.8)
n/a	76.3 (3.7)	78.5 (3.6)	n/a	n/a	68.9 (4.1)	68.9 (4.1)	64.2 (4.4)	n/a
72.4 (3.9)	74.3 (3.8)	72.4 (3.9)	70.6 (4.0)	70.6 (4.0)	67.3 (4.2)	65.7 (4.3)	61.4 (4.6)	56.5 (5.0)
70.6 (4.0)	n/a	n/a	68.9 (4.1)	68.9 (4.1)	64.2 (4.4)	62.8 (4.5)	58.9 (4.8)	55.4 (5.1)
n/a	68.9 (4.1)	68.9 (4.1)	n/a	n/a	62.8 (4.5)	64.2 (4.4)	60.1 (4.7)	n/a
65.7 (4.3)	67.3 (4.2)	65.7 (4.3)	62.8 (4.5)	65.7 (4.3)	61.4 (4.6)	62.8 (4.5)	58.9 (4.8)	53.3 (5.3)
64.2 (4.4)	n/a	n/a	61.4 (4.6)	64.2 (4.4)	60.1 (4.7)	61.4 (4.6)	57.6 (4.9)	52.3 (5.4)

²Fuel consumption and CO₂ emissions figures are obtained under standardised test conditions (Directive 93/116/EEC) using a representative model. This allows direct comparison between different models from different manufacturers, but may not represent the actual fuel consumption achieved in 'real world' driving conditions and may be affected by optional equipment. More information is available at www.dft.gov.uk/vca

S4 technical data

Key information about your car.

Our S4 engine meets EU6 emissions standards.

	Saloon	Avant
Engine	3.0 V6 TFSI quattro	3.0 V6 TFSI quattro
Transmission	8-speed tiptronic	8-speed tiptronic
Cylinder	6-cylinder	6-cylinder
Displacement, cubic cm (valves per cylinder)	2995	2995
Max. power; ¹ PS at rpm	354/5400-6400	354/5400-6400
Performance		
Max. torque, Nm at rpm	500/1370-4500	500/1370-4500
0-62mph acceleration, seconds	4.7	4.9
Top speed, mph	155	155
Weight		
Unladen weight; ² kg	1630	1675
Gross weight limit, kg	2200	2265
Further information		
Roof load limit/nose weight	90/80	90/80
Max trailer load unbraked ³	750	750
Max trailer load with 12%/8% gradient ³	1900/2100	1900/2100
Fuel tank approx capacity, litres	58	58
AdBlue [®] tank approx capacity, litres	n/a	n/a
ABI insurance group 1-50 ⁴	TBC	TBC

¹The given value was obtained in accordance with the specified measurement procedure (the respective current version of the Directive 80/1269/EEC). The maximum power output figures are quoted in PS (or Pferdestärke, which is the metric equivalent of brake horsepower). To convert to brake horsepower, divide the PS figure by 1.0139.
²Vehicle's unladen weight without driver (calculated in accordance with the current version of Directive (80/1268/EEC). The fitting of additional equipment may increase the vehicle's unladen weight and drag coefficient, whereupon the potential carrying capacity and top speed will be correspondingly reduced.

Depending on your chosen S4 wheel size, different efficiency figures for CO₂ emissions and fuel consumption will apply (based on EU directive no. 715/2007 effective 01/09/14). This table is a quick reference guide to help you find the correct values based on wheel sizes and your chosen engine.

	Saloon	Avant
Engine	3.0 V6 TFSI quattro	3.0 V6 TFSI quattro
Transmission	8-speed tiptronic	8-speed tiptronic
Max. power; ¹ PS at rpm	354/5400-6400	354/5400-6400
Wheel and Tyre Clustering		
CO ₂ emissions, ⁵ g/km	17" wheels	-
	18" wheels	166
	19" wheels	170
Benefit in kind 2016/17 tax year (BIK)%	17" wheels	-
	18" wheels	30%
	19" wheels	31%
Fuel consumption, ⁵ mpg (l/100km) Urban	17" wheels	-
	18" wheels	28.8 (9.8)
	19" wheels	28.5 (9.9)
Fuel consumption, ⁵ mpg (l/100km) Extra Urban	17" wheels	-
	18" wheels	47.9 (5.9)
	19" wheels	46.3 (6.1)
Fuel consumption, ⁵ mpg (l/100km) Combined	17" wheels	-
	18" wheels	38.7 (7.3)
	19" wheels	37.7 (7.5)

³The engine's power output always goes down with increasing altitude. At 1,000m above sea level, and for every additional 1,000m, deduct 10% from the weight of the outfit (trailer load limit + gross weight of the towing vehicle). ⁴Highest insurance group rating shown. Group may be lower dependent on trim level. Please visit www.thatcham.org/abigrouprating for details. ⁵Fuel consumption and CO₂ emissions figures are obtained under standardised test conditions (Directive 93/116/EEC) using a representative model. This allows direct comparison between different models from different manufacturers, but may not represent the actual fuel consumption achieved in 'real world' driving conditions and may be affected by optional equipment. More information is available at www.dft.gov.uk/vca

A4 Saloon and Avant dimensions

All the measurements you need.

See the exact dimensions of the Audi A4 Saloon and Avant, so you can check everything – from whether the car fits your garage to whether your luggage fits the boot.

A4 Saloon

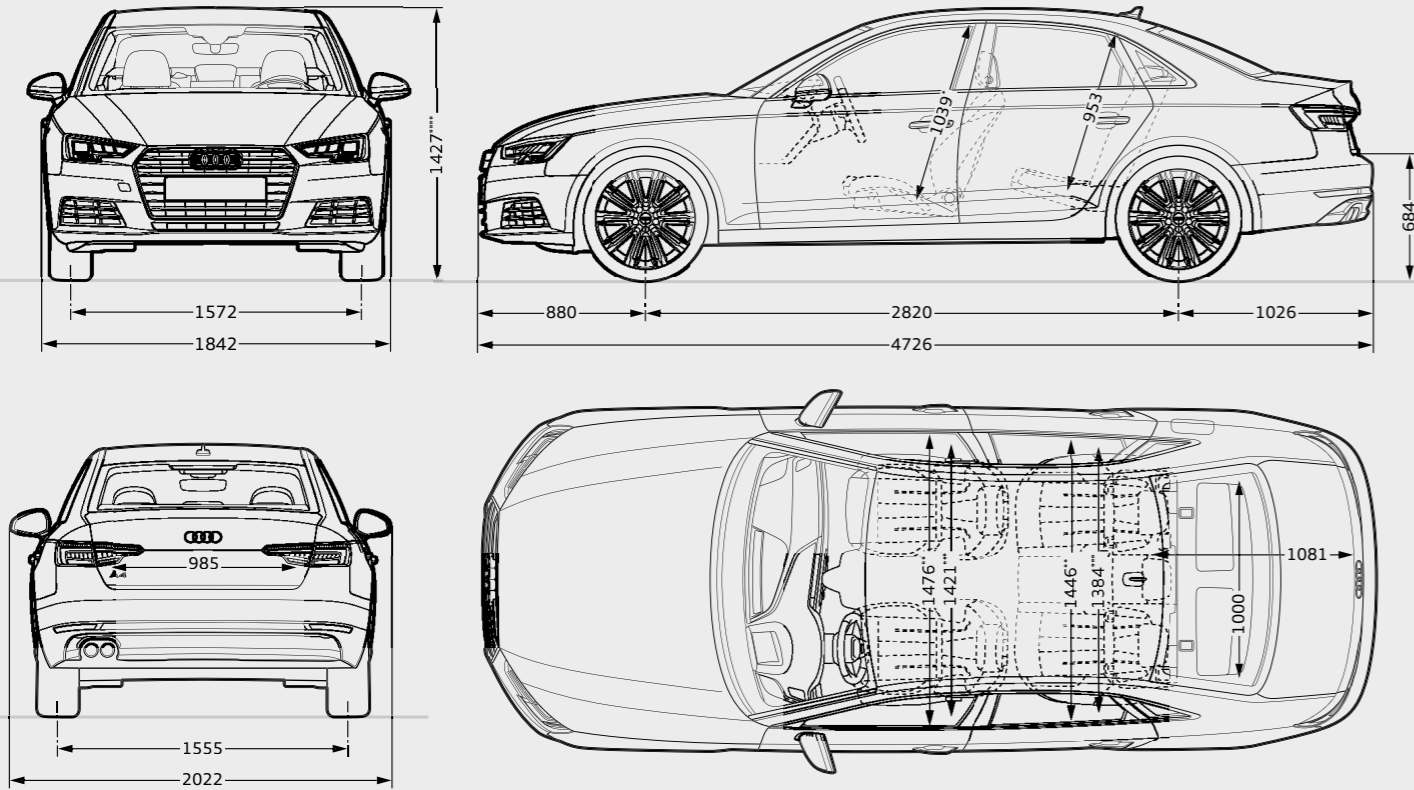

Saloon luggage compartment capacity:****
480l (rear seats up) or 965l (rear seats folded down).

A4 Avant

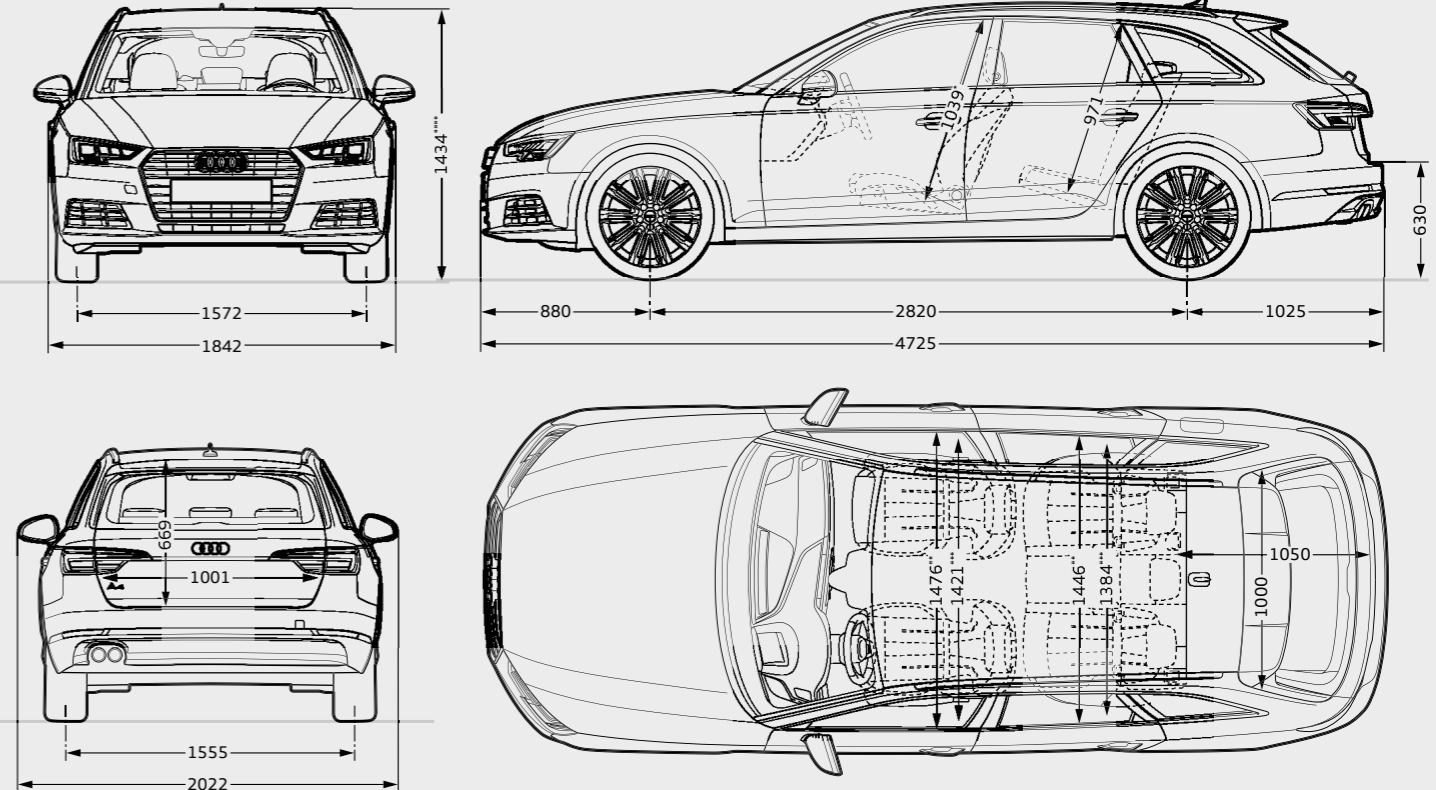

Avant luggage compartment capacity:****
505l (rear seats up) or 1510l (rear seats folded down).

Dimensions in millimetres. Optional equipment may affect dimensions. *Maximum headroom. **Elbow room width. ***Shoulder room width. Dimensions were measured with vehicle at unladen weight. ****Measured by the VDA standard test method using 200 x 100 x 50mm blocks. Turning circle approx. 11.6m.

S4 Saloon and Avant dimensions

All the measurements you need.

See the exact dimensions of the all-new Audi A4 Saloon and Avant, so you can check everything – from whether the car fits your garage to whether your luggage fits the boot.

S4 Saloon

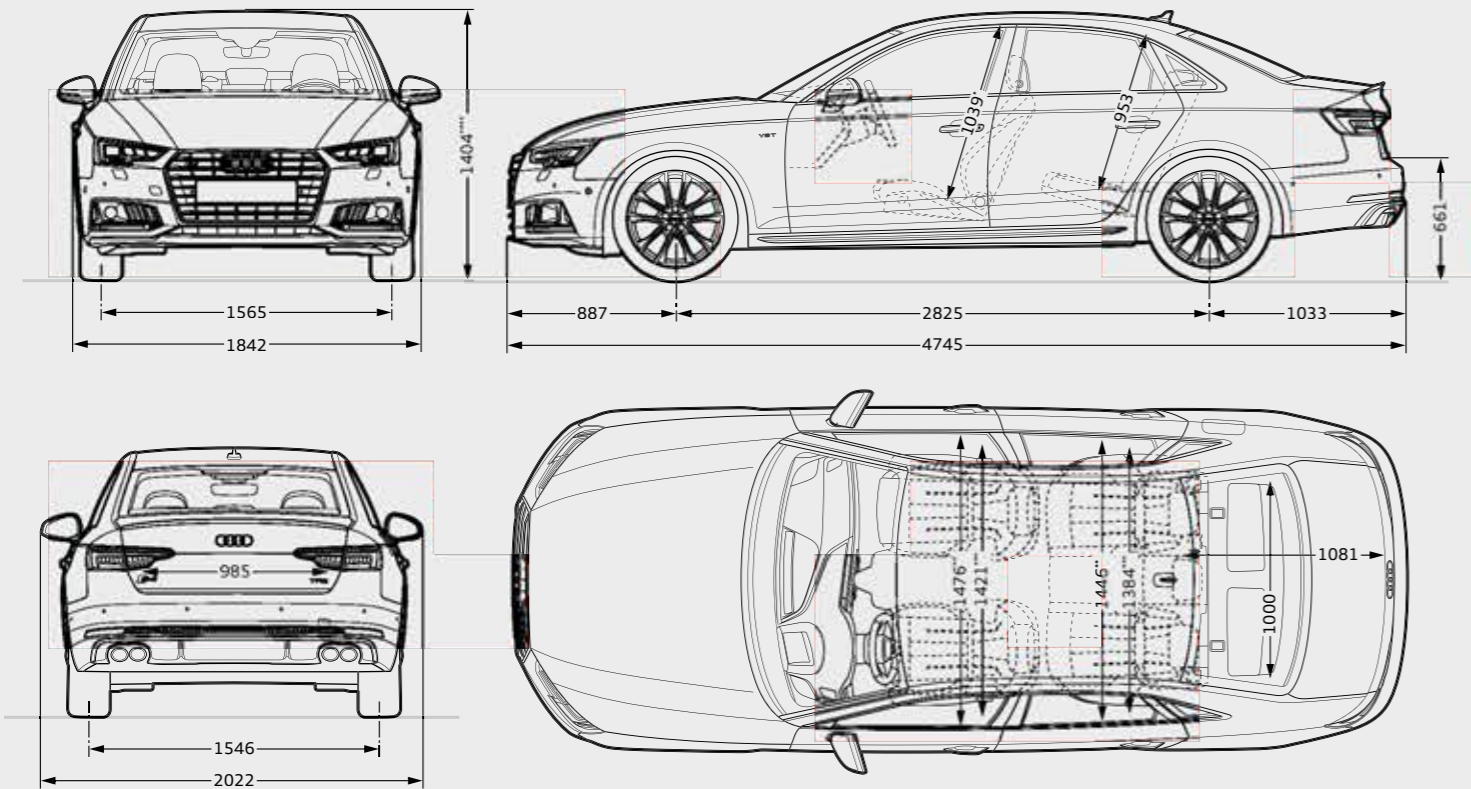

Saloon luggage compartment capacity:****
480l (rear seats up) or 965l (rear seats folded down).

S4 Avant

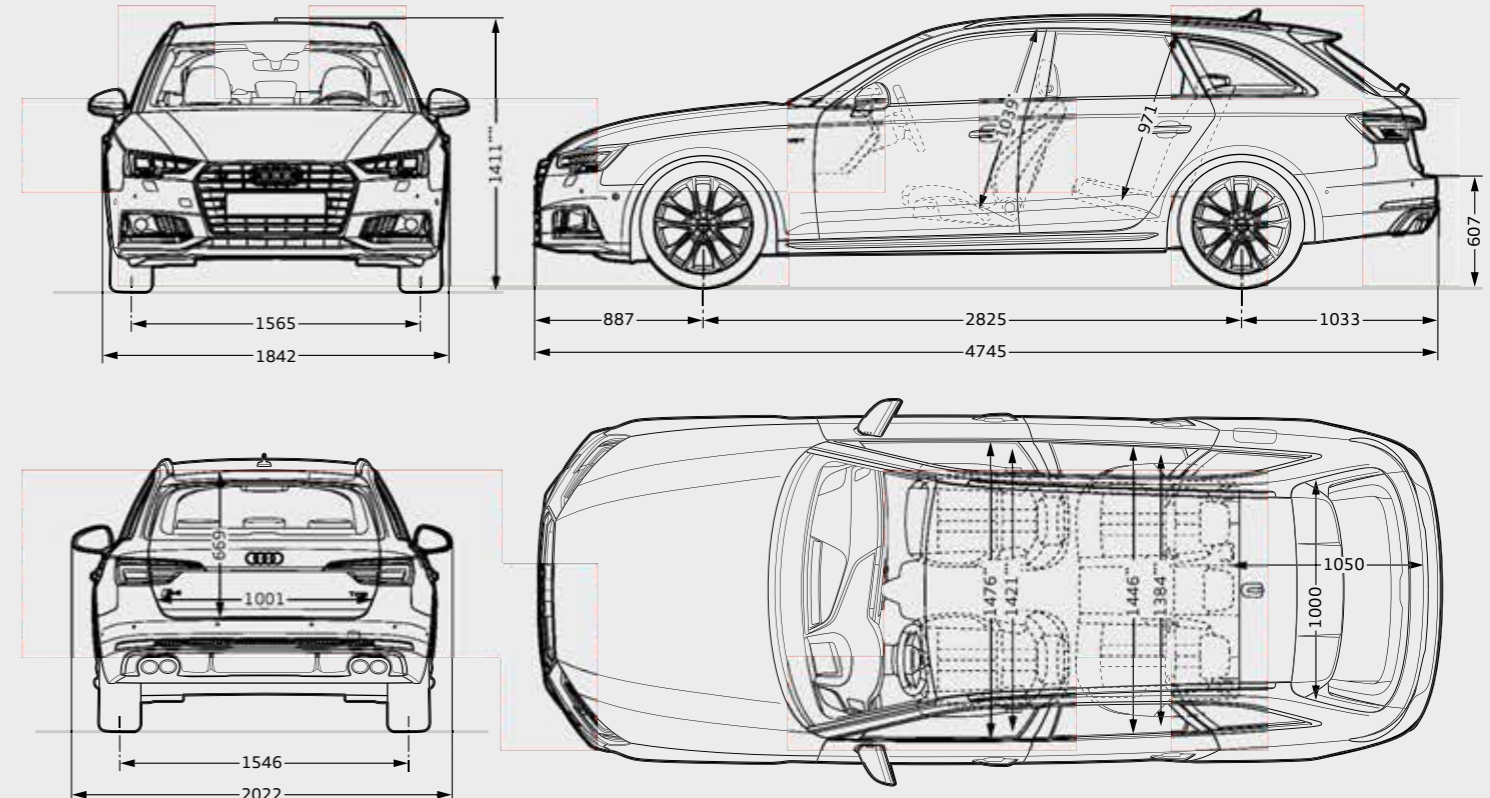

Avant luggage compartment capacity:****
505l (rear seats up) or 1510l (rear seats folded down).

Dimensions in millimetres. Optional equipment may affect dimensions. *Maximum headroom. **Elbow room width. ***Shoulder room width. Dimensions were measured with vehicle at unladen weight. ****Measured by the VDA standard test method using 200 x 100 x 50mm blocks. Turning circle approx. 11.6m.

The Audi **Difference**

There's no single factor that makes an Audi Centre the right place to bring your car for servicing or maintenance. Really, it's the sum of many different parts. Together, we call them the Audi Difference.

Servicing by Audi

Regular servicing is key to the smooth running of your Audi. We offer Audi service schedules designed with your car in mind. There are two main types: fixed, where servicing is due after a set time or mileage, and flexible, where sensors will monitor your driving style and alert you when a service is needed.

Fixed Inspection Service Schedule

Vehicle Usage	
Mileage	Less than 10,000 miles per annum. Mainly city/town centre driving. Short journeys.
Service Intervals	
Oil-Change Service	Fixed to every 9,000 ¹ miles/one year
Inspection Service	Fixed to every 19,000 ¹ miles/two years

Flexible Service Schedule

Vehicle Usage	
Mileage	More than 10,000 miles per annum. Motorway and main road driving. Mainly longer distance journeys. Constant speeds.
Service Intervals	
Oil-Change Service	Variable to a maximum of every 19,000 ¹ miles/two years
Inspection Service	Fixed to every 19,000 ¹ miles/two years

When a vehicle is frequently used in the following conditions, we recommend a Fixed Inspection Service Schedule, regardless of mileage: Uneconomical driving styles, e.g. heavy acceleration and braking, constant use of high revs. High engine-loading conditions, e.g. frequent towing and hill climbs. ¹As indicated by the service interval display. Mileages are approximate as the Service Indicator system uses kilometres as its distance measurement. ²Subject to availability.

Everything you need

Book a 'service while you wait' appointment, or leave your car with us and take advantage of a courtesy car,² which we can even deliver to you. We will also ensure your car is returned to you with a full valet.

Genuine parts, genuine prices

When we work on your car, we'll only use Audi Genuine Parts, which come with a 2-year guarantee (excludes wear and tear). So you know they'll be of the same high standards as the originals.

We'll keep you updated

Whenever we see your Audi, we'll connect it directly to our headquarters in Ingolstadt for the latest software updates. These can be applied immediately, enhancing everything from your car's efficiency to the precision of its parking system.

Audi Roadside Assistance

For even more reassurance, your Audi comes with three years' complimentary roadside assistance provided by the Automobile Association Insurance Services Limited. It means you'll be covered across the UK and throughout Europe in the unlikely event of a breakdown. For more information, please visit www.audi.co.uk/roadside

Financing your Audi A4

A range of finance plans designed to suit you.

Simply go to www.audi.co.uk and enter a few details to see the monthly payments you could be making on a new Audi A4.

Below we've outlined some of the different options available – you just need to choose your annual mileage and length of term, then pay an initial deposit that could be as little as one monthly payment.

Solutions Personal Contract Plan

A flexible finance plan designed to give you a number of options, making it ideal if you want to change your car more regularly. At the end of the agreement, you have three choices:

1. Exchange the car for a new Audi.
2. Pay the option to purchase fee and optional final payment, then take full ownership of the car.
3. Simply return the car to Audi (fees may be payable).

Hire Purchase

If you know you'd like to keep your Audi, Hire Purchase could be right for you. And as you're making your payments with a view to owning the car, there's no restriction on how far you can drive each year.

Contract Hire

If you don't want to own your Audi, Contract Hire could be a great option. You can add a service, maintenance and tyres plan and, for VAT-registered businesses, an element of the VAT on rentals may be recoverable. You simply need to commit to a regular monthly payment and hand your car back at the end of your agreement (subject to our return standards).

Online Finance Calculator

To get an idea of your repayments on a finance scheme, enter a few details online at audi.co.uk and you'll see what you can expect to pay for your new Audi.

Audi Insurance

To ensure you can start enjoying your new car from day one, the first five days' insurance* is included as standard with all new Audi models. To activate it, simply call 0330 303 6900, give us a few details and you can drive it away as soon as you take delivery.

Telephone lines are open Monday to Friday 8am–8pm, and Saturday 9am–4pm. For details of our full range of insurance products, visit www.insurewithaudi.co.uk

*Subject to eligibility criteria. Audi Motor Insurance is sold and administered by Ageas Retail Limited. Audi Financial Services is a trading name of Volkswagen Financial Services (UK) Limited ("VWFS UK"). Registered in England and Wales No. 2835230. Registered Office: Brunswick Court, Yeomans Drive, Blakelands, Milton Keynes MK14 5LR. Financial and consumer credit services are provided by VWFS UK. Volkswagen Financial Services (UK) Limited is authorised and regulated by the Financial Conduct Authority, registration number 311988. Audi Motor Insurance from Audi Financial Services is sold and administered by Ageas Retail Limited, registered in England and Wales No. 1324965. Registered office: Ageas House, Hampshire Corporate Park, Templars Way, Eastleigh, Hampshire SO53 3YA. Ageas Retail Limited is authorised and regulated by the Financial Conduct Authority (FCA), registration number 312468. Volkswagen Financial Services (UK) and Ageas Retail Limited are not part of the same corporate group.

Important information

Welcome to Audi.

By placing an order for your Audi, you're choosing to drive a car created in the spirit of Vorsprung durch Technik. And because we believe the service we offer should reflect the quality of our cars, we want to let you know exactly what you can expect from us, now and in the future.

Audi customer care

Every new Audi includes these reassuring features as standard:

- ▶ 3-year Audi warranty (unlimited-mileage in the first two years, with a full mechanical and electrical warranty up to 60,000 miles in the third year)
- ▶ A 3-year paint warranty
- ▶ A 12-year anti-corrosion warranty
- ▶ 3-year UK roadside assistance and recovery
- ▶ 3-year Accessories warranty on any accessories purchased with your car (2-year warranty if purchased separately from your new Audi)*

You also have the option when ordering your new car of choosing a 4-year or 5-year Audi warranty. Speak to a member of the sales team for more information. Warranty terms and conditions apply. Please see www.audi.co.uk/warrantyterms for further details.

Information in this guide

We've done all we can to make the prices, specifications, technical details and all other information you see in this guide accurate at the time of publication. However, as our products are constantly being updated, we recommend checking the details with your Audi Centre. We reserve the right to change prices or specification at any time.

All prices shown in this guide include VAT which is currently charged at 20%. Delivery charges and number plates are not included in the Total RRP inc VAT vehicle price.

Delivery charge	£504.99
Number plate	£20.00
VAT	£105.01
Total	£630.00

Recommended On-The-Road (OTR) prices include the delivery and number plate charges above, Road Fund Licence (which may vary depending on model/transmission – see table for details) and first registration fee at £55.00.

The images featured in this guide are for illustrative purposes only. They may feature left-hand drive vehicles and include equipment that is not UK specification.

Audi tax-free sales

If you are entitled to purchase a vehicle free of VAT, normally through military or diplomatic privilege, please contact your local Audi Centre for full details. Should you have any difficulty obtaining the information you require, please call 0870 241 5663.

CO2 emissions-based Vehicle Excise Duty

Vehicle Excise Duty (Road Fund Licence) is based upon the amount of Carbon Dioxide (CO₂) a vehicle emits, measured in grams per kilometre (g/km). First year VED rates apply to the first year of ownership. Annual VED rates apply thereafter. The DVLA has created 13 categories:

Petrol and Diesel engines	First year	Annual rate (second year onwards)
A – up to 100g/km	£0	£0
B – 101 to 110g/km	£0	£20
C – 111 to 120g/km	£0	£30
D – 121 to 130g/km	£0	£110
E – 131 to 140g/km	£130	£130
F – 141 to 150g/km	£145	£145
G – 151 to 165g/km	£185	£185
H – 166 to 175g/km	£300	£210
I – 176 to 185g/km	£355	£230
J – 186 to 200g/km	£500	£270
K – 201 to 225g/km	£650	£295
L – 226 to 255g/km	£885	£500
M – over 255g/km	£1,120	£515

Vehicle Excise Duty (VED) rates correct at time of going to print, but these may alter to reflect any change in the applicable VED rate.

Important information

Audi Connect Infotainment Services

Audi Connect Infotainment Services are provided via a SIM card embedded in the vehicle. The cost for data connection is free of charge during the standard 3-month free trial or included within the cost of the optional Audi Connect Infotainment Services 36-month subscription. Data is unlimited (but you will not, for example, be able to use the embedded SIM to provide Wi-Fi hotspot services or to tether any other device to the embedded SIM). There are no additional charges for data roaming within the EU, (availability of services limited to certain countries). Please note that, if an external SIM card is inserted into the card slot (e.g. so as to enable Wi-Fi hot spot services), then all Audi Connect Infotainment Services data connections will be made via this SIM card (not the embedded SIM card) and all related data costs incurred may be charged to the customer by the provider of the plan associated with the external SIM card.

Audi Connect Infotainment Services are available only within the range of the selected mobile phone network operated by Audi's chosen mobile phone provider. The content and scope of the online based services offered may vary.

Audi Connect Infotainment Services enables access to the certain search, social media and other online services provided by third parties. Permanent availability cannot be guaranteed as this is the responsibility of the relevant third party provider. Google and the Google logo are registered trademarks of Google Inc. All other trade marks are the property of their respective owners.

The availability of services supported by Audi Connect Infotainment Services varies from country to country and can be dependent on the capability of your mobile phone. For mobile phone and software compatibility please visit www.audi.co.uk/phonecompatibility or your Audi Centre.

Audi Connect Infotainment Services 3-month trial

The 3-month free use of Audi Connect Infotainment Services is activated from vehicle delivery. Should you wish to continue with the services after the three months please consult your Audi Centre for details. Charges will apply upon renewal. The Audi Connect Infotainment Services listed are correct at time of publication, please be aware that we cannot guarantee permanent availability to all these services throughout the 3-month trial.

Audi Connect Infotainment Services 36-month subscription

If purchased as part of the optional Technology Pack, a 36-month subscription for the use of Audi Connect Infotainment Services is activated from vehicle delivery. The Audi Connect Infotainment Services listed are correct at time of publication, please be aware that we cannot guarantee permanent availability to all these services throughout your subscription. Should you wish to continue to use Audi Connect Infotainment Services after 36 months please consult your Audi Centre for details. Charges will apply upon renewal.

Online Map updates with MMI Navigation Plus

The map version delivered for the optional MMI Navigation Plus can be updated with the first five updates which are issued at intervals of six months. The current navigation data can be downloaded from the myAudi Platform at www.audi.com/myaudi and installed in the vehicle via SD card. In combination with Audi Connect, the update can be carried out online in the vehicle. In addition, it is possible to have the new navigation data installed by an Audi Centre at extra cost.

Audi Vorsprung durch Technik



Audi UK
Customer Services
Selectapost 29
Sheffield
S97 3FG
0800 699888
www.audi.co.uk

Specifications and prices subject
to change without notice.

© Audi (UK)

Printed in the UK
Edition 1.5 10/16
2017 Model Year

Images are for illustrative purposes only.
Models shown are left-hand drive.